



RFQ No.: 410065975

OPEN TENDER NOTIFICATION

FOR

**OLA OF POWER CONNECTION INFRASTRUCTURE WORKS FOR
MAHARASHTRA 1 YEARS**

Tender Enquiry No.: 410065975
Due Date for Bid Submission: 01.07.2026 [05.00 PM Hrs.]

The Tata Power Company Limited
Mumbai, Maharashtra

RFQ No.: 4100065975

CONTENTS OF THE ENQUIRY

S. NO.	PARTICULARS
1.	Event Information
2.	Evaluation Criteria
3.	Submission of Bid Documents
4.	Bid Opening & Evaluation process
5.	Award Decision
6.	Order of Preference/Contradiction
7.	Post Award Contract Administration
8.	Specifications and Standards
9.	General Conditions of Contract
10.	Safety
Annexures	
I.	Annexure I – Schedule of Items
II.	Annexure II – Technical Specifications/Scope of Work
III.	Annexure III – Schedule of Deviations
IV.	Annexure IV – Schedule of Commercial Specifications
V.	Annexure V – Document Check List
VI.	Annexure VI – Acceptance Form for Participation in Reverse Auction Event
VII.	Annexure VII – Inspection Test Plan
VIII.	Annexure VIII – General Condition of Contract
IX.	Annexure IX – Safety Terms & conditions and Safety Bid Format
X.	Tata Code of Conduct
XI.	Health and Safety Policy
XII.	Corporate Environment Policy
XIII.	Format for Earnest Money Deposit (EMD) Bank Guarantee



RFQ No.: 4100065975

1. Event Information

1.1 Scope of work

Open Tenders are invited in e-tender bidding process from interested Bidders for the following work as defined below:

S. No.	Description	EMD Amount (Rs.)	Tender Fee (Rs.)
1	OLA of Power connection infrastructure works for Maharashtra 1 years	INR 70,000	2000

1.2 Availability of Tender Documents

Non-Transferable Tender documents may be downloaded by interested eligible bidders from TPC website www.tatapower.com with effect from 09.06.2026. The Tender Fee shall be submitted online through NEFT/ RTGS in favor of "The Tata Power Company Limited". Any such bid submitted without this Fee shall be rejected.

Bidders are requested to visit TPC website www.tatapower.com regularly for any modification/clarification to the bid documents.

1.3 Calendar of Events

(a)	Date of availability of tender documents from TPC Website	From 09.06.2026 to 01.07.2026, 05:00 PM Hrs
(b)	Date & Time of Pre-Bid Meeting (If any)	17.06.2026, 11:00 AM Hrs
(c)	Last Date of receipt of pre-bid queries, if any	17.06.2026, 05:00 PM Hrs
(d)	Last Date of Posting Consolidated replies to all the pre-bid queries as received	22.06.2026, 05:00 PM Hrs
(e)	Last date and time of receipt of Bids	01.07.2026, 05:00 PM Hrs
(f)	Date & Time of opening of Price of qualified bids	Will be notified to the successful bidders through our website / e-mail.

Note :- In the event of last date specified for submission of bids and date of opening of bids is declared as a closed holiday for TPC Mumbai office, the last date of submission of bids and date of opening of bids will be the following working day at appointed times.

1.4 Mandatory documents required along with the Bid.

- 1.4.1 EMD of requisite value and validity.
- 1.4.2 Tender Fee in case the tender is downloaded from website.
- 1.4.3 Requisite Documents for compliance to Qualification Criteria mentioned in Clause 1.7.
- 1.4.4 Drawing, Type Test details along with a sample of each item as specified at Annexure I (as applicable)
- 1.4.5 Duly signed and stamped 'Schedule of Deviations' as per Annexure III on bidder's letter head.
- 1.4.6 Duly signed and stamped 'Schedule of Commercial Specifications' as per Annexure IV on bidder's letter head.

RFQ No.: 4100065975

- 1.4.7 Proper authorization letter/ Power of Attorney to sign the tender on the behalf of bidder.
- 1.4.8 Copy of PAN, GST, PF and ESI Registration (In case any of these documents is not available with the bidder, same to be explicitly mentioned in the 'Schedule of Deviations')
- 1.4.9 Compliance to the technical requirement (Attached in Scope of Work)

Please note that in absence of any of the above documents, the bid submitted by a bidder shall be liable for rejection.

1.5 Deviation from Tender

Normally, the deviations to tender terms are not admissible and the bids with deviation are liable for rejection. Hence, the bidders are advised to refrain from taking any deviations on this Tender. Still in case of any deviations, all such deviations shall be set out by the Bidders, clause by clause in the 'Annexure III - Schedule of Deviations' and same shall be submitted as a part of the Technical Bid.

1.6 Right of Acceptance/Rejection

Bids are liable for rejection in absence of following documents: -

- 1.6.1 EMD of requisite value and validity
- 1.6.2 Tender fee of requisite value
- 1.6.3 Price Bid as per the Price Schedule mentioned in Annexure-I
- 1.6.4 Necessary documents against compliance to Qualification Requirements mentioned at Clause 1.7 of this Tender Document.
- 1.6.5 Filled in Schedule of Deviations as per Annexure III
- 1.6.6 Filled in Schedule of Commercial Specifications as per Annexure IV
- 1.6.7 Receipt of Bid within the due date and time.

TPC reserves the right to accept/reject any or all the bids without assigning any reason thereof.

1.7 Qualification Criteria

Sr No	Parameter	Criteria
1	Technical Experience	<p>1) Bidder must have all Statutory Compliance like Valid PAN, ESI registration, EPF registration & GSTN Registration. Copy of all the certificates shall be submitted in this regard.</p> <p>2) Bidders must have successfully executed, in the previous 3 (three) years from the date of bid submission, similar kind of orders for at least the one of the following values. Similar works include Supply, Installation and Commissioning of HT or LT Systems. Bidders shall submit relevant copies of orders or completion certificates in this regard.</p> <ul style="list-style-type: none"> a. One Order of order value not less than Rs. Fifteen Lakhs each b. Two Orders of Order Value not Less than Rs. Ten Lakhs each c. Three Orders of order value not less than Rs. Seven Lakhs each d. Any no. of Orders for a cumulative value not less than Rs. Twenty Lakhs <p>3) Bidder should have valid Electrical Contractor License for competent authority for execution of the contract at the designated location. Bidders should submit relevant copies of licenses in this regard. In case bidder does not have electrical license for the state</p>



RFQ No.: 4100065975

		then undertaking shall be submitted stating that necessary electrical license for the state shall be taken within 3 months from the date of award of the contract.
2	Financial Criteria	The Bidder should have average annual turnover of Rs. Thirty Lakhs (Rs. 30,00,000/-) in previous 3 financial years. Copy of audited balance Sheet and P&L account to be submitted in this regard. UDIN No. shall be mandatorily mentioned on the audited documents. If the bidder has started operation in the past 2 years, then average annual turnover for the past 2 years will be considered and should be equal to or more than Rs. 30,00,000/-. Such bidder should submit a document substantiating the start of business in the past 2 years.

1.8 Marketing Integrity

We have a fair and competitive marketplace. The rules for bidders are outlined in the General Condition of Contracts. Bidders must agree to these rules prior to participating. In addition to other remedies available, TPC reserves the right to exclude a bidder from participating in future markets due to the bidder's violation of any of the rules or obligations contained in the General Condition of Contracts. A bidder who violates the marketplace rules or engages in behavior that disrupts the fair execution of the marketplace, may result in restriction of a bidder from further participation in the marketplace for a length of time, depending upon the seriousness of the violation. Examples of violations include, but are not limited to:

- Failure to honor prices submitted to the marketplace.
- Breach of terms as published in TENDER/ NIT

1.9 Supplier Confidentiality

All information contained in this tender is confidential and shall not be disclosed, published or advertised in any manner without written authorization from TPC. This includes all bidding information submitted to TPC. All tender documents remain the property of TPC and all suppliers are required to return these documents to TPC upon request. Suppliers who do not honor these confidentiality provisions will be excluded from participating in future bidding events.

1.0 Evaluation Criteria

- The bids will be evaluated technically on the compliance to tender terms and conditions.
- The bids will be evaluated commercially on the overall all-inclusive lowest cost for the complete tender BOQ as calculated in Schedule of Items [Annexure I]. TPC however, reserves right to split the order line item wise and/or quantity wise among more than one Bidder. Hence all bidders are advised to quote their most competitive rates against each line item.
- Bidder must mandatorily quote against each item of Schedule of Items [Annexure I]. Failing to do so, TPC may reject the bids.

NOTE: In case of a new bidder not registered, factory inspection and evaluation shall be carried out to ascertain bidder's manufacturing capability and quality procedures. However, TPC reserves the right to carry out factory inspection and evaluation for any bidder prior to technical qualification. In



RFQ No.: 4100065975

case a bidder is found as Disqualified in the factory evaluation, their bid shall not be evaluated any further and shall be summarily rejected. The decision of TPC shall be final and binding on the bidder in this regard.

1.1 Price Variation Clause:

The prices shall remain firm during the entire contract period.

2.0 Submission of Bid Documents

3.1 Bid Submission

Bidders are requested to submit their offer in line with this Tender document. TPC shall respond to the clarification raised by various bidders and the replies will be sent to all participating bidders through e-mail.

Bids shall be submitted in 3 (Three) parts:

FIRST PART: “EMD” of Rs 70,000/- (Rupees Seventy Thousand only) shall be submitted. The EMD shall be valid for 210 days from the due date of bid submission in the form of BG / Bankers Pay Order favoring “The Tata Power Company Limited”. The EMD has to be strictly in the format as mentioned in General Condition of Contract, failing which it shall not be accepted, and the bid as submitted shall be liable for rejection. A separate non-refundable tender fee of stipulated amount also needs to be transferred online through NEFT/ RTGS in case the tender document is downloaded from our website.

TPC/ TPC Bank Details for transferring Tender Fee and EMD is as below:

Account Name: The Tata Power Co. Ltd.

Bank Name: HDFC Bank, Fort Branch, Mumbai

Bank Account No. : 00600110000763

IFSC Code: HDFC0000060

SECOND PART: “TECHNICAL BID” shall contain the following documents:

- a) Documentary evidence in support of qualifying criteria
- b) Technical literature/GTP/Type test report etc. *(if applicable)*
- c) Qualified manpower available
- d) Testing facilities *(if applicable)*
- e) Signed Post Award Contract Administration (Clause 7.0)
- f) No Deviation Certificate as per the Annexure III – Schedule of Deviations
- g) Acceptance to Commercial Terms and Conditions viz Delivery schedule/period, payment terms etc. as per the Annexure IV – Schedule of Commercial Specifications.
- h) Quality Assurance Plan/Inspection Test Plan for supply items *(if applicable)*

The technical bid shall be properly indexed and is to be submitted in Soft Copy through Ariba Portal only. Hard Copy of Technical Bids need not be submitted.

THIRD PART: “PRICE BID” shall contain only the price details and strictly in format as mentioned in Annexure I along with explicit break up of basic prices, Taxes & duties, Freight etc. In case any discrepancy is observed between the item description stated in Schedule of Items mentioned in the



RFQ No.: 4100065975

tender and the price bid submitted by the bidder, the item description as mentioned in the tender document (to the extent modified through Corrigendum issued if any) shall prevail.

FOR BIDS INVITED THROUGH E-PROCUREMENT PORTAL:

The interested bidders are requested to obtain username and password for purpose of bid submission through Ariba portal of TPC, Mumbai

Bids have to be mandatorily submitted only through Ariba portal of TPC. Bids submitted through any other form/ route shall not be admissible.

The EMD in the form of BG shall be submitted in original hard copy and then placed in sealed envelope which shall be clearly marked as below:

**EMD
Tender Name:**

Please mention our Enquiry Number (RFQ No.) on the Tender and drop the same at The Tata Power Company Limited, Smart Center of Procurement Excellence, 2nd Floor, Sahar Receiving Station, Sahar Airport Road, Andheri East, Mumbai-400059.

The envelope shall be addressed to:

Chief (Corporate Contracts)
The Tata Power Company Limited
Smart Center of Procurement Excellence, 2nd Floor, Sahar Receiving Station
Sahar Airport Road, Andheri East, Mumbai-400059

The envelope shall also bear the Name and Address of the Bidder along with our Tender No. and subject.

3.0 SIGNING OF BID DOCUMENTS:

The bid must contain the name, residence, and place of business of the person or persons making the bid and must be signed and sealed by the Bidder with his usual signature. The names of all persons signing should also be typed or printed below the signature.

The Bid being submitted must be signed by a person holding a Power of Attorney authorizing him to do so, certified copies of which shall be enclosed.

The Bid submitted on behalf of companies registered with the Indian Companies Act, for the time being in force, shall be signed by persons duly authorized to submit the Bid on behalf of the Company and shall be accompanied by certified true copies of the resolutions, extracts of Articles of Association, special or general Power of Attorney etc. to show clearly the title, authority and designation of persons signing the Bid on behalf of the Company. Satisfactory evidence of authority of the person signing on behalf of the Bidder shall be furnished with the bid.

A bid by a person who affixes to his signature the word 'President', 'Managing Director', 'Secretary', 'Agent' or other designation without disclosing his principal will be rejected.

The Bidder's name stated on the Proposal shall be the exact legal name of the firm.

3.2 Contact Information



RFQ No.: 4100065975

All the bidders are requested to send their pre-bid queries (if any) against this tender through e-mail within the stipulated timelines. The consolidated reply to all the queries received shall be shared on respective registered mail ID by the stipulated timelines as detailed in calendar of events.

Communication Details:

Corporate Contracts

Name: Mr. Mandar Pise
Contact No: 7620581071
E-Mail ID: mandar.pise@tatapower.com

Group Head Contracts

Name: Deepan Prasad N A
Contact No.: 9971395344
E-Mail ID: deepan.prasad@tatapower.com

3.3 Bid Prices

Bidders shall quote for the entire Scope of Supply/ work with a breakup of prices for individual items and Taxes & duties. The bidder shall complete the appropriate Price Schedules included herein, stating the Unit Price for each item & total price with taxes, duties & freight up to destination at various sites of TPC. The all-inclusive prices offered shall be inclusive of all costs as well as Duties, Taxes and Levies paid or payable during the execution of the supply work, breakup of price constituents.

The quantity breakup shown elsewhere other than Price Schedule is tentative. The bidder shall ascertain himself regarding material required for completeness of the entire work. Any items not indicated in the price schedule, but which are required to complete the job as per the Technical Specifications/ Scope of Work/ SLA mentioned in the tender, shall be deemed to be included in prices quoted.

3.4 Bid Currencies

Prices shall be quoted in Indian Rupees Only.

3.5 Period of Validity of Bids

Bids shall remain valid for 180 days from the due date of submission of the bid.

Notwithstanding clause above, the TPC may solicit the Bidder's consent to an extension of the Period of Bid Validity. The request and responses thereto shall be made in writing.

3.6 Alternative Bids

Bidders shall submit Bids, which comply with the Bidding documents. Alternative bids will not be considered. The attention of Bidders is drawn to the provisions regarding the rejection of Bids in the terms and conditions, which are not substantially responsive to the requirements of the bidding documents.

3.7 Modifications and Withdrawal of Bids

The bidder is not allowed to modify or withdraw its bid after the Bid's submission. The EMD as submitted along with the bid shall be liable for forfeiture in such event.

RFQ No.: 4100065975

3.8 Earnest Money Deposit (EMD)

The bidder shall furnish, as part of its bid, an EMD amounting as specified in the tender. The EMD is required to protect the TPC against the risk of bidder's conduct which would warrant forfeiture.

The EMD shall be denominated in any of the following form:

- Banker's Cheque/ Demand Draft/ Pay order drawn in favor of The Tata Power Company Limited, payable at Mumbai.
- Online transfer of requisite amount through NEFT/ RTGS.
- Bank Guarantee valid for 210 days after due date of submission.

The EMD shall be forfeited in case of:

a) The bidder withdraws its bid during the period of specified bid validity.

Or

b) The case of a successful bidder, if the Bidder does not

i) accept the purchase order, or

ii) furnish the required performance security BG.

3.9 Type Tests (if applicable)

As per attached Annexures

4.0 Bid Opening & Evaluation process.

4.1 Process to be confidential.

Information relating to the examination, clarification, evaluation and comparison of Bids and recommendations for the award of a contract shall not be disclosed to Bidders or any other persons not officially concerned with such process. Any effort by a Bidder to influence the TPC's processing of Bids or award decisions may result in the rejection of the Bidder's Bid.

4.2 Technical Bid Opening

Bids will be opened at TPC Office Mumbai as per the schedule mentioned in Calendar of Events. In case of limited tenders, the bids shall be opened internally by TPC. In case of Open Tenders, the bids shall be opened in the presence of accredited representatives of bidders who may choose to be present at the time of tender opening. Technical bid must not contain any cost information whatsoever.

First the envelope marked "EMD" will be opened. Bids without EMD/cost of tender (if applicable) of required amount/ validity in prescribed format, shall be rejected.

Next, the technical bid of the bidders who have furnished the requisite EMD will be opened, one by one. The salient particulars of the techno commercial bid will be read out at the sole discretion of TPC.

4.3 Preliminary Examination of Bids/Responsiveness

TPC will examine the Bids to determine whether they are complete, whether any computational errors have been made, whether required sureties have been furnished, whether the documents have been properly signed, and whether the Bids are generally in order. TPC may ask for submission of original documents in order to verify the documents submitted in support of qualification criteria.

Arithmetical errors will be rectified on the following basis: If there is a discrepancy between the unit price and the total price per item that is obtained by multiplying the unit price and quantity, the unit price shall prevail and the total price per item will be corrected. If there is a discrepancy between the



RFQ No.: 4100065975

Total Amount and the sum of the total price per item, the sum of the total price per item shall prevail and the Total Amount will be corrected.

Prior to the detailed evaluation, TPC will determine the substantial responsiveness of each Bid to the Bidding Documents including production capability and acceptable quality of the Goods offered. A substantially responsive Bid is one, which conforms to all the terms and conditions of the Bidding Documents without material deviation.

Bid determined as not substantially responsive will be rejected by the TPC and/or the TPC and may not subsequently be made responsive by the Bidder by correction of the non-conformity.

4.4 Techno Commercial Clarifications

Bidders need to ensure that the bids submitted by them are complete in all respects. To assist in the examination, evaluation, and comparison of Bids, TPC may, at its discretion, ask the Bidder for a clarification on its Bid for any deviations with respect to the TPC specifications and attempt will be made to bring all bids on a common footing. All responses to requests for clarification shall be in writing and no change in the price or substance of the Bid shall be sought, offered, or permitted owing to any clarifications sought by TPC.

4.5 Price Bid Opening

Price bids will be opened at the stipulated date and time. The EMD of the bidder withdrawing or substantially altering his offer at any stage after the technical bid opening will be forfeited at the sole discretion of TPC without any further correspondence in this regard.

4.7 Reverse Auctions

TPC reserves the right to conduct the reverse auction (instead of public opening of price bids) for the products/ services being asked for in the tender. The terms and conditions for such reverse auction events shall be as per the Acceptance Form attached as Annexure VI of this document. The bidders along with the tender document shall mandatorily submit a duly signed copy of the Acceptance Form attached as Annexure VI as a token of acceptance for the same.

5.0 Award Decision

TPC will award the contract to the successful bidder whose bid has been determined to be the lowest-evaluated responsive bid as per the Evaluation Criterion mentioned at Clause 2.0. The Cost for the said calculation shall be taken as the all-inclusive cost quoted by bidder in Annexure I (Schedule of Items) subject to any corrections required in line with Clause 4.3 above. The decision to place purchase order/LOI solely depends on TPC on the cost competitiveness across multiple lots, quality, delivery and bidder's capacity, in addition to other factors that TPC may deem relevant.

TPC reserves all the rights to award the contract to one or more bidders so as to meet the delivery requirement or nullify the award decision without assigning any reason thereof.

In case any supplier is found unsatisfactory during the delivery process, the award will be cancelled and TPC reserves the right to award other suppliers who are found fit.

6.0 Order of Preference/Contradiction:

In case of contradiction in any part of various documents in tender, following shall prevail in order of preference:

RFQ No.: 4100065975

1. Schedule of Items (Annexure I)
2. Post Award Contract Administration (Clause 7.0)
3. Submission of Bid Documents (Clause 3.0)
4. Scope of Work and SLA (Annexure VII)
5. Technical Specifications (Annexure II)
6. Inspection Test Plan (Annexure VIII)
7. Acceptance Form for Participation in Reverse Auction (Annexure VI)
8. General Conditions of Contract (Annexure IX)

7.0 Post Award Contract Administration

7.1 Special Conditions of Contract

- Rate shall remain FIRM till the validity of Rate Contract.
- TPC appreciates and welcomes the engagement/employment of persons from SC/ ST community or any other deprived section of society by their BAs.
- Any change in statutory taxes, duties and levies during the contract period shall be borne by TPC. However, in case of delay in work execution owing to reasons not attributable to TPC, any increase in total liability shall be passed on the Bidder, whereas any benefits arising owing to such statutory variation in taxes and duties shall be passed on TPC.
- All the terms and conditions of TPC GTC shall be applicable.

7.2 Drawing Submission & Approval

As per scope of work

7.3 Delivery Terms

- Deliverables as per SLA mentioned in the scope of work.

7.4 Warranty Period

Transformer & VCB = 5 years and 1 years on of all kinds of supply, installation & services from date of commissioning.

7.5 Payment Terms

For Infrastructure work: Invoice shall be raised after completion of the work and handover of the site. Credit Period shall be 60 days for non-MSME vendors and 45 days for MSME vendors.

For Liaisoning Work: Payment shall be made to the Vendor based upon the milestones defined as under:

I. First Instalment (50%): Fifty percent (50%) payments against the applied connection shall be paid on DN receipt verified & accepted/approved by TPEVCSL after submission of following documents:

- (i) Copy of Demand note issued by Discom comprising of detailed breakup of Security deposit and other processing fees, Infra work details etc.
- (ii) Clearly indicating the mode of payment of Demand note i.e. Online payment, RTGS/NEFT/DD in favour of xyz or any other mode as applicable.



RFQ No.: 4100065975

(iii) In case of online payment the payment link along with used name and password must be clearly mentioned.

(iv) Confirmation from Discom that Demand note payment has been received by Discom in intended account for further action.

II. Second Instalment (50%): Fifty percent (50%) payments against the applied connection shall be paid on successful installation of Energy meter at the designated location/premises after submission of following documents:

(i) Meter installation certificate issued by Discom.

(ii) LEC/WCR submission as per the format provided by TPEVCSL.

The aforesaid payments shall be subject to receipt of invoices along with enclosures/supporting documents for having completed the Job according to the Scope and duly verified/certified by Owner's Order Manager against which payment is being claimed. Payments due to the Contractor shall be made after deduction of the Liquidated Damages (LD) amount, TDS, Safety Retention etc. as applicable.

7.6 Liquidated Damages

SLA applicable as per scope of work

7.7 Contract Performance Bank Guarantee (CPBG)

Vendor shall submit irrevocable and unconditional Contract Performance Bank Guarantee (CPBG) for a value equal to 5% of the contract value, within 15 days from the receipt of contract valid till the Warranty Period with a further claim period of 6 months.

7.8 LD / SLA / Performance Requirement and penalties

SLA applicable as per scope of work

7.9 Other Terms & Conditions

Upon work award the successful bidder shall provide support services as listed in the scope of work and SLA.

7.10 Climate Change

Significant quantities of waste are generated during the execution of project and an integrated approach for effective handling, storage, transportation, and disposal of the same shall be adopted. This would ensure the minimization of environmental and social impact in order to combat the climate change.

7.11 Ethics

TPC is an ethical organization and as a policy TPC lays emphasis on ethical practices across its entire domain. Bidder should ensure that they should abide by all the ethical norms and in no form either directly or indirectly be involved in unethical practice.

TPC work practices are governed by the Tata Code of Conduct which emphasizes on the following:

RFQ No.: 4100065975

- We shall select our suppliers and service providers fairly and transparently.
- We seek to work with suppliers and service providers who can demonstrate that they share similar values. We expect them to adopt ethical standards comparable to our own.
- Our suppliers and service providers shall represent our company only with duly authorized written permission from our company. They are expected to abide by the Code in their interactions with, and on behalf of us, including respecting the confidentiality of information shared with them.
- We shall ensure that any gifts or hospitality received from, or given to, our suppliers or service providers comply with our company's gifts and hospitality policy.
- We respect our obligations on the use of third-party intellectual property and data.

Bidder is advised to refer GTC attached at Annexure VIII for more information.

Any ethical concerns with respect to this tender can be reported to the following e-mail ID: cecounsellor@tatapower.com or via third party facility tatapower@ethics-line.com

8 Specification and standards

As per Annexure II.

9 General Condition of Contract

Any condition not mentioned above shall be applicable as per GCC for Supply attached along with this tender at Annexure IX.

10 Safety

Safety related requirements as mentioned in our safety Manual put in the Company's website which can be accessed by:

<http://www.tatapower.com>

All Associates shall strictly abide by the guidelines provided in the safety manual at all relevant stages during the contract period.



RFQ No.: 4100065975

ANNEXURE I
Schedule for Items

RFQ no 4100065975					
Tender Name -OLA of Power connection infrastructure works for Maharashtra 1 years					
SI No	BOQ Descriptionn	UoM (B)	Quantity (C)	Basic Unit Rate (D) Rs.	BoQ Price (E = C*D) Rs.
1	Distribution transformer of 63kva, 11/0.433 kV, 3 Phase, level-2,Aluminium wound, distribution transformers outdoor type oil immersed,supply,loading,unloading, transportation, erection, testing and commissioningof distribution transformer with all accessories complete.	EA	1		₹ -
2	Distribution transformer of 63kva,22/0.433kv, level-2 three phase,Copper wound, distribution transformers outdoor type oil immersed withoutcsp feature for agricultural (individual or group)connections,supply,loading,unloading, transportation, erection, testing and commissioningof distribution transformer with all accessories complete.	EA	1		₹ -
3	Distribution transformer of 100 kva, 11/ 0.433 kv , (level-2) three ph,Aluminium wound oil immersed, outdoor, non sealed type without csp feature dist.trans.,supply,loading,unloading, transportation, erection, testing and commissioningof distribution transformer with all accessories complete.	EA	5		₹ -



RFQ No.: 4100065975

4	Distribution transformer of 100 kva, 22/ 0.433 kv, (level-2) three ph, Copper wound oil immersed, outdoor, non sealed type without csp feature dist.trans.,supply,loading,unloading, transportation, erection, testing and commissioningof distribution transformer with all accessories complete.	EA	1		₹	-
5	Distribution transformer of 200 kva, 11/ 0.433 kv (level-2) three phase,Aluminium wound non sealed, oil immersed outdoor type distribution transformers.,supply,loading,unloading, transportation, erection, testing and commissioningof distribution transformer with all accessories complete.	EA	8		₹	-
6	Distribution transformer of 200 kva, 22/0.433 kv,(level-2) three phase,Copper wound non sealed, oil immersed outdoor type distribution transformers.,supply,loading,unloading, transportation, erection, testing and commissioningof distribution transformer with all accessories complete.	EA	2		₹	-
7	Distribution transformer of 315 kva,11/0.433 kv,(level-2) three phase,Copper wound non sealed, oil immersed outdoor type distribution with off circuit tap changer, as per CEA guideline, supply,loading,unloading, transportation, erection, testing and commissioningof distribution transformer with all accessories complete.	EA	3		₹	-
8	Distribution transformer of 315 kva, 22/0.433 kv,(level-2) three phase,Copper wound non sealed, oil immersed outdoor type distribution transformers, with off circuit tap changer, as per CEA guideline, supply,loading,unloading, transportation, erection, testing and commissioningof distribution transformer with all accessories complete.	EA	1		₹	-



RFQ No.: 4100065975

9	Supply,Unloading, Shifting, Erection, Testing & Commissioning Of 11 KV 630A, 3Way(2+1) RMU, outdoor Type Manual With 3Nos. SF6 Panel Boards with Standard Metering & Protections, SCADA compatible SF6 Ring Main Unit(3 Way) with enclousre and including all standard accessories as per DISCOM specification	Nos	2		₹	-
10	Supply,Unloading, Shifting, Erection, Testing & Commissioning Of 22 KV 630A, 25 kA 3Way(2+1) RMU, outdoor Type Manual With 3Nos. SF6 Panel Boards with Standard Metering & Protections, SCADA compatible SF6 Ring Main Unit(3 Way) with enclousre and including all standard accessories as per DISCOM specification	Nos	1		₹	-
11	Supply, Erection, testing and commissioning of 11 kv, 630 A, 18.4 kA for 3 seconds, 3-ph, outdoor type Vacuum Circuit breaker (1 I/C & 1 O/G) by supplying and fixing ISMC 100 channel with its levelling, alignment and welding on existing cable trench in control room with required accessories etc complete for following arrangements and protection as per approved drawings, technical specifications and scope of the work. :	Nos	1		₹	-
12	Supply, Erection, testing and commissioning of 22 kv, 630 A, 18.4 kA for 3 seconds, 3-ph, outdoor type Vacuum Circuit breaker (1 I/C & 1 O/G) by supplying and fixing ISMC 100 channel with its levelling, alignment and welding on existing cable trench in control room with required accessories etc complete for following arrangements and protection as per approved drawings, technical specifications and scope of the work. :	Nos	1		₹	-
13	Supply, installation of 11 kv HT metering cubicle including CT, PT, meter as per DISCOM requirement. Entire responsibility of SITC of meter and CT PT including laboratory testing as per DISCOM Specification.	Nos	3		₹	-



RFQ No.: 4100065975

14	Supply, installation of 22 kV HT metering cubicle including CT, PT, meter as per DISCOM requirement. Entire responsibility of SITC of meter and CT PT including laboratory testing as per DISCOM Specification.	Nos	1		₹	-
15	Construction of Transformer foundation, Transformer plinth with plastering, RCC pedestal as per TPC & DISCOM Specification.	Nos	5		₹	-
16	Construction of RMU/VCB/LBS/Metering Cubicle foundation, Transformer plinth with plastering, RCC pedestal as per TPC & DISCOM Specification.	Nos	12		₹	-
17	Supply & installation of 9 Meter PSC Pole 400 Kg WL with Excavation of pole pit (of depth 1/6th of pole length) in normal soil & Erection of poles by supplying concrete base slab & cement concrete foundation made of 1 part cement, 3 part sand, 6 part 40 mm size stone aggregate chips (1:3:6) as per TS along with providing and installing of danger plate, anti-climbing devices (barbed wire) as per DISCOM scope of work and technical specification.	Nos	2		₹	-
18	Supply & installation of 13 M Long RS Joist Pole(150x150) with Excavation of pole pit (of depth 1/6th of pole length) in normal soil & Erection of poles by supplying concrete base slab & cement concrete foundation made of 1 part cement, 3 part sand, 6 part 40 mm size stone aggregate chips (1:3:6) and muffing made of 1 part cement, 2 part sand, 4 part 40 mm size stone aggregate chips (1:2:4) as per TS and including painting by red oxide, aluminium paint, black anti corrosive paint along with providing and installing of danger plate, anti-climbing devices (barbed wire) as per DISCOM scope of work and technical specification.	Nos	15		₹	-



RFQ No.: 4100065975

19	Supply & installation of 11 M Long RS Joist Pole(116x100) with Excavation of pole pit (of depth 1/6th of pole length) in normal soil & Erection of poles by supplying concrete base slab & cement concrete foundation made of 1 part cement, 3 part sand, 6 part 40 mm size stone aggregate chips (1:3:6) and muffing made of 1 part cement, 2 part sand, 4 part 40 mm size stone aggregate chips (1:2:4) as per TS and including painting by red oxide, aluminium paint , black anti corrosive paint along with providing and installing of danger plate, anti-climbing devices (barbed wire)as per DISCOM scope of work and technical specification.	Nos	15		₹	-
20	Supply & installation of 9 M Long RS Joist Pole(116x100) with Excavation of pole pit (of depth 1/6th of pole length) in normal soil & Erection of poles by supplying concrete base slab & cement concrete foundation made of 1 part cement, 3 part sand, 6 part 40 mm size stone aggregate chips (1:3:6) and muffing made of 1 part cement, 2 part sand, 4 part 40 mm size stone aggregate chips (1:2:4) as per TS and including painting by red oxide, aluminium paint , black anti corrosive paint along with providing and installing of danger plate, anti-climbing devices (barbed wire)as per DISCOM scope of work and technical specification.	Nos	2		₹	-
21	Supply , Erection, testing, commissioning of Pre-fabricated hot dip galvanised steel items like DP top mounting channel, transformer mounting channel, isolater base channel, transformer clamping set, transformer belting set, DP cross arm, back clamps, pole clamps, HG Fuse mounting channel , back/pole clamps , V bracket, Top adopter, LT brackets, LT Box Brackets, D-iron Clamps, pole clamps etc. made of MS Channel (100x50x6), (75x40x6), MS angle (65x65x6),(50x50x6), MS Flat (50x6),(25x3) of given sizes for Sub station structure/for 22KV,11KV,LT over head ,Earthing ,structures etc. as required with supply & erection of galvanised nuts, bolts & washers.) as per DISCOM scope of work and technical specification.	KG	5000		₹	-

Property of TPC – Not to be reproduced without prior written permission of TPC.



RFQ No.: 4100065975

22	Supply & Laying and fabrication of GI strip 50*6 mm GI strip. The scope includes sup. of 50X6 GI strip,necessary hardware such as spacer,scaddle,nut,bolts etc. The joining of earthing strips to be welded & bolted as per requirement with overlapping of minimum 100 mm.	Meter	50		₹	-
23	Supply,Erection of complete HT SET having anchor plate (230x230x6),1.83 m long, 20 mm, diameter solid GS Stay rod,GI nut & bolts, washer ,binding of Guy wire, by providing Guy insulator (1 Nos.), 1 No turn buckle by 0.2 cmt concreting 1 part cement, 3 part sand, 6 part 40 mm size stone aggregate chips (1:3:6) and ramming by earth & brickbat as per DISCOM scope of work and technical specification.	Set	5		₹	-
24	7/4 mm dia G.I. stranded Stay Wire (7/8 SWG)as per DISCOM scope of work and technical specification.	KG	50		₹	-
25	Supply,Erection,testing & Commissioning of 11 KV Insulator with Hardware Fittings complete as required for DTR and 11 KV line Polymer Disc Insulators 45KN/70 KN as per DISCOM scope of work and technical specification.	Nos	50		₹	-
26	Supply,Erection,testing & Commissioning of 22 KV Insulator with Hardware Fittings complete as required for DTR and 22 KV line Polymer Disc Insulators 45KN/70 KN as per DISCOM scope of work and technical specification.	Nos	10		₹	-
27	Supply,Erection,testing & Commissioning of 11 KV Insulator with Hardware Fittings complete as required for DTR and 11 KV line Polymer PIn Insulators 5KN as per DISCOM scope of work and technical specification.	Nos	50		₹	-
28	Supply,Erection,testing & Commissioning of 22 KV Insulator with Hardware Fittings complete as required for DTR and 22 KV line Polymer PIn Insulators 10 KN as per DISCOM scope of work and technical specification.	Nos	10		₹	-



RFQ No.: 4100065975

29	Supply & Erection, testing and commissioning of 11 kV, 3-ph, D.O. Fuse Unit, Polymer type 100 A, complete as per DISCOM scope of work and technical specification. (1 set is equal to 3 Nos.)	Set	18		₹	-
30	Supply & Erection, testing and commissioning of 22 kV, 3-ph, D.O. Fuse Unit, Polymer type 100 A, complete as per DISCOM scope of work and technical specification. (1 set is equal to 3 Nos.)	Set	2		₹	-
31	11 KV, 3-ph, AB Switch Polymer type 400 Amp as per Discom requirement with Complete fitting .Isolator along with Support Insulators, Base Channel, down Pipe, Arcing Horns etc. complete and Erection, testing and commissioning as per DISCOM scope of work and technical specification. (1 set is equal to 3 Nos.)	Set	18		₹	-
32	22 KV, 3-ph, AB Switch Polymer type 400 Amp as per Discom requirement with Complete fitting .Isolator along with Support Insulators, Base Channel, down Pipe, Arcing Horns etc. complete and Erection, testing and commissioning as per DISCOM scope of work and technical specification. (1 set is equal to 3 Nos.)	Set	2		₹	-
33	Supply & Erection, testing and commissioning of 11 KV ,5/10KA Polymeric type Lightning Arresters as per Discom requirement Gapless type as per technical specification, Complete and Erection, testing and commissioning as per DISCOM scope of work and technical specification. (1 set is equal to 3 Nos.)	Set	50		₹	-
34	Supply & Erection, testing and commissioning of 22 KV ,10KA Polymeric type Lightning Arresters as per Discom requirement Gapless type as per technical specification, Complete and Erection, testing and commissioning as per DISCOM scope of work and technical specification. (1 set is equal to 3 Nos.)	Set	10		₹	-



RFQ No.: 4100065975

35	Supply & Erection, testing and Commissioning , 1 NOs Pipe Earthing using 40/ 50 mm dia GI Pipe, 3000 mm long C grade type Galvanized nut & bolt washer with providing Bentonite compound powder/Charcol & Salt, for complete earthing of Distribution Transformer Substations as per TPEVCSL and DISCOM scope of work and technical specification.	Nos	70		₹	-
36	Supply & Errection/installation of Earth Electrode (Flat In Pipe) GI:GI 3 Meter/80mm - JEF ECO Safe Environment Friendly Maintenance Free Earthing System Consisting of(A) 17.2 MM DIA LOW CARBON STEEL ROD WITH MOLECULAR BONDED COPPER TO A THICKNESS OF 250 MICRONS OF 3 MTR. LONG (B) ONE BAG OF LORESCO SPECIAL POWER SET BACK FILL COMPOUND OF 50 POUNDS (C) ONE DOUBLE SIDED CLAMP.	Nos	10		₹	-
37	50 X 6 mm 110 microns Cu coated Strips (Neutral Earthing For CSS),scope includes necessary painting and hardware such as insulated spacer, insulated saddle,nut,bolts etc. as per standard. The joining of earthing strips to be welded & bolted as per requirement with overlapping of minimum 100 mm	M	10		₹	-
38	Supply,Laying & Dressing of following 1.1 KV ,XLPE Al Armoured 4 core 300 SQ. MM cable in the Distribution Box/CT Metering Box connection ,and including Supply and Erection of double compression brass cable glands, lugs/ thimbles,termination etc. complete .as per DISCOM scope of work and technical specification.	Meter	50		₹	-
39	Supply,Laying & Dressing of following 1.1 KV ,XLPEAl Armoured 4 core 185 SQ. MM cable in the Distribution Box/CT Metering Box connection ,and including Supply and Erection of double compression brass cable glands, lugs/ thimbles,termination etc. complete ,as per DISCOM scope of work and technical specification.	Meter	200		₹	-



RFQ No.: 4100065975

40	Supply,Laying & Dressing of following 1.1 KV ,XLPEAI Armoured 4 core 120 SQ. MM cable in the Distribution Box/CT Metering Box connection ,and including Supply and Erection of double compression brass cable glands, lugs/ thimbles,termination etc. complete,as per DISCOM scope of work and technical specification.	Meter	25		₹	-
41	Supply,Laying & Dressing of following 1.1 KV ,XLPEAI Armoured 4 core 95 SQ. MM cable in the Distribution Box/CT Metering Box connection ,and including Supply and Erection of double compression brass cable glands, lugs/ thimbles,termination etc. complete as per DISCOM scope of work and technical specification.	Meter	50		₹	-
42	Supply,Laying & Dressing of following 1.1 KV ,XLPEAI Armoured 4 core 70 SQ. MM cable in the Distribution Box/CT Metering Box connection ,and including Supply and Erection of double compression brass cable glands, lugs/ thimbles,termination etc. complete .as per DISCOM scope of work and technical specification.	Meter	50		₹	-
43	Supply,Laying & Dressing of following 1.1 KV ,XLPEAI Armoured 4 core 50 SQ. MM cable in the Distribution Box/CT Metering Box connection ,and including Supply and Erection of double compression brass cable glands, lugs/ thimbles,termination etc. complete .as per DISCOM scope of work and technical specification.	Meter	50		₹	-
44	Supply,Laying & Dressing of following 1.1 KV ,XLPEAI Armoured 4 core 35 SQ. MM cable in the Distribution Box/CT Metering Box connection ,and including Supply and Erection of double compression brass cable glands, lugs/ thimbles,termination etc. complete .as per DISCOM scope of work and technical specification.	Meter	50		₹	-



RFQ No.: 4100065975

45	Supply,Laying,temination & Dressing of 3 CORE 11 KV GRADE Al Armoured 95 SQ. MM ,XLPE cable including necessary materials complete and Design, engineering, construction, supply of labour, and including Supply and Erection of double compression brass cable glands, lugs/ thimbles, etc. complete as per DISCOM scope of work and technical specification.	Meter	100		₹	-
46	Supply,Laying,temination & Dressing of 3 CORE 11 KV GRADE Al Armoured 120 SQ. MM ,XLPE cable including necessary materials complete and Design, engineering, construction, supply of labour, and including Supply and Erection of double compression brass cable glands, lugs/ thimbles, etc. complete as per DISCOM scope of work and technical specification.	Meter	50		₹	-
47	Supply,Laying & Dressing of following XLPE CABLE 3 CORE 11 KV GRADE Al Armoured185 SQ. MM KV XLPE cable in the Distribution Box/CT Metering Box connection ,andincluding Supply and Erection of double compression brass cable glands, lugs/thimbles etc. complete .	Meter	25		₹	-
48	Supply,Laying & Dressing of following XLPE CABLE 3 CORE 11 KV GRADE Al Armoured300 SQ. MM KV XLPE cable in the Distribution Box/CT Metering Box connection ,andincluding Supply and Erection of double compression brass cable glands, lugs/thimbles etc. complete .	Meter	25		₹	-
49	Supply,Laying,temination & Dressing of 3 CORE 22 KV GRADE Al Armoured 95 SQ. MM ,XLPE cable including necessary materials complete and Design, engineering, construction, supply of labour, and including Supply and Erection of double compression brass cable glands, lugs/ thimbles, etc. complete as per DISCOM scope of work and technical specification.	Meter	10		₹	-
50	Supply & installation of heat shrink outdoor end termination along with Clamp of cable size 11 KV ,3C *95/120 SQ MM XLPE (E) insulated AL conductor	Nos	15		₹	-

Property of TPC – Not to be reproduced without prior written permission of TPC.



RFQ No.: 4100065975

51	S & I and termination of Heat Shrinkable Outdoor/Indoor Termination Kit for ,11 KV, 3 C x 185 sq mm Al Armoured XLPE cable complete as per DISCOM scope of work and technical specification.	Nos	2		₹	-
52	S & I and termination of Heat Shrinkable Outdoor/Indoor Termination Kit for,11 KV, 3 C x 300 sq mm Al Armoured XLPE cable complete as per DISCOM scope of work and technical specification.	Nos	2		₹	-
53	S & I and termination of Heat Shrinkable Outdoor/Indoor Termination Kit for ,22 KV, 3 C x 95 sq mm Al Armoured XLPE cable complete as per DISCOM scope of work and technical specification.	Nos	2		₹	-
54	ELEC,"Supply erection and termination of 1.1 kV 4C x 95 sq.mm to 10 sq.mm aluminum armoured XLPE cables with lugs/thimbles PVC tape etc complete along with the supply and erection of double compression brass cable glands . The work shall be completed in accordance with the TPEVCSL Project Manager (make as per the scope of work)"	Nos	2		₹	-
55	Supply & Outdoor End termination of 1.1 kV (E) 4C x120/180 Sq.mm XLPE Armoured Cable, AL cable along with double compression gland of brass, lugs, PVC tape & all other accessories	Nos	15		₹	-
56	Supply & Outdoor End termination of 1.1 kV (E) 4C x 300 Sq.mm XLPE Armoured Cable along with double compression gland of brass, lugs, PVC tape & all other accessories	Nos	15		₹	-
57	Supply & Laying of heavy duty HDPE Pipe 160 mm (dia)NB HDPE pipe 10 mm (thickness) PE-80,PN-6 and associated material and as per IS:4984-1995 as per DISCOM scope of work and technical specification.	Meter	100		₹	-



RFQ No.: 4100065975

58	Supply & Laying of heavy duty HDPE Pipe of 110 mm (dia)NB HDPE pipe 10 mm (thickness) PE-80,PN-6 and associated materials as per IS:4984-1995 as per DISCOM scope of work and technical specification.	Meter	25		₹	-
59	Supply & Laying of of Hume Pipe 150 mm Dia for Cable instruction of the site Engineer, as per DISCOM scope of work and technical specification.	Meter	100		₹	-
60	Supply & Laying of of Hume Pipe 100 mm Dia for Cable instruction of the site Engineer, as per DISCOM scope of work and technical specification.	Meter	25		₹	-
61	Supply, Installation of Half round cement pipe (150mm X 1mtr) as per DISCOM scope of work and technical specification.	Nos	25		₹	-
62	Supply, Installation of 100 mm Dia PVC pipe	Meter	50		₹	-
63	Soil excavation by digging of burried trench depth of proper dimension maintaining statutory depth from the /by cutting of metalled road/cement concrete/brick soiling etc , in trench, cable bonding & earthing, providing adequate brick & sand protection to the laid cable, backfilling of earth, compaction, levelling i.e re-instatement of the same as per DISCOM scope of work and technical specification.	Meter	300		₹	-
64	Supply & Stringing, sagging, binding, jumpering testing and commissioning of Weasel Conductor 30 sq mm for DTR/ 11 KV/LT Line and supply & erection of PG Clamp,Al Binding, Strain hardware wire etc. complete as per DISCOM.	Km	0.75		₹	-
65	Supply & Stringing, sagging, binding, jumpering testing and commissioning of Rabbit Conductor of 50 sq mm for DTR/ 11 KV/LT Line and supply & erection of PG Clamp,Al Binding, Strain hardware wire etc. complete as per DISCOM.	Km	0.75		₹	-
66	Supply & Stringing, sagging, binding, jumpering testing and commissioning of Dog Conductor of 100 sq mm for DTR/ 11 KV/LT Line and supply & erection of PG Clamp,Al Binding, Strain hardware wire etc. complete as per DISCOM.	Km	0.75		₹	-

Property of TPC – Not to be reproduced without prior written permission of TPC.



RFQ No.: 4100065975

67	Supply ,Installation, testing and Commissioning of Outdoor mounting type Distribution box for 63/100 KVA, with incomer isolator of 200A,HRC Fuse,EC grade AL bus(25X10 mm) ,MCCB, Link Disconnecter, separate neutral bus bar ,made of 2 mm CRCA sheet (as per IS:513) with with made of MS, dust and moisture vermin(Thickness of Rubber Linimg -4 mm), weather proof with degree of protection(IP-33) with suitable bus bars, earthing bus, earthing terminals, box illumination, front door operated with proper locking arrangement,Powder Coating Light Admiralty Grey IS:5: 1993,Color No-697 after 7 tank Phosphating Process,Size-1000(L)X1010(H)x325(W) mm lugs, mounting channel frame, internal wiring with FRLS cables, danger plate, Double Compression cable Galnd, numbering, back clamps, hardware as per DISCOM TS complete	Nos	6		₹ -
68	Supply ,Installation, testing and Commissioning of Outdoor mounting type Distribution box for 200 KVA, with incomer Isolator of 400A, HRC Fuse of 400A ,EC grade AL bus(50X10 mm) ,MCCB, Link Disconnecter, separate neutral bus bar ,made of 2 mm CRCA sheet (as per IS:513) with with made of MS, dust and moisture vermin(Thickness of Rubber Linimg -4 mm), weather proof with degree of protection(IP-33) with suitable bus bars, earthing bus, earthing terminals, box illumination, front door operated with proper locking arrangement,Powder Coating Light Admiralty Grey IS:5: 1993,Color No-697 after 7 tank Phosphating Process,Size-1000(L)X1010(H)x325(W) mm lugs, mounting channel frame, internal wiring with FRLS cables, danger plate, Double Compression cable Galnd, numbering, back clamps, hardware as per DISCOM TS complete	Nos	10		₹ -



RFQ No.: 4100065975

69	Supply & Instln, Testing & Commissioning of '3 Phase , 433V , 50Hz , 630 A 'Floor Mounted DB / MCCB Panel which Consist of 4P, 3 phase , 433V, 50Hz , 36KA, 630A MCCB, with panel metering, RYB indicator etc as per drawings/specs of TPEVCSL. The rate includes fixing and grouting foundation with fasteners, securing board to frame/foundation, fixing and connecting of all accessories and instruments,Nomenclature of incoming and outgoing circuits,etc	Nos	1		₹	-
70	Supply & Instln, Testing & Commissioning of '3 Phase , 433V , 50Hz , 800 A 'Floor Mounted DB / MCCB Panel which Consist of 4P, 3 phase , 433V, 50Hz , 36KA, 800A MCCB, with panel metering, RYB indicator etc as per drawings/specs of TPEVCSL. The rate includes fixing and grouting foundation with fasteners, securing board to frame/foundation, fixing and connecting of all accessories and instruments,Nomenclature of incoming and outgoing circuits,etc	Nos	2		₹	-
71	Supply & Instln, Testing & Commissioning of '3 Phase , 433V , 50Hz , 800 A 'Floor Mounted DB ACB Panel which Consist of 4P, 3 phase , 433V, 50Hz , 36KA, 800A ACB, with panel metering, RYB indicator etc as per drawings/specs of TPEVCSL. The rate includes fixing and grouting foundation with fasteners, securing board to frame/foundation, fixing and connecting of all accessories and instruments,Nomenclature of incoming and outgoing circuits,etc	Nos	1		₹	-
72	Supply ,Installation, testing and Commissioning of Outdoor mounting type LT feeder pillar 4 way, with made of MS 2 mm CRCA sheet, dust and moisture vermin, weather proof with degree of protection with suitable bus bars, earthing bus, earthing terminals, box illumination, front door operated with proper locking arrangement, lugs, mounting channel frame, internal wiring with FRLS cables, danger plate, numbering, back clamps, hardware as per DISCOM TS complete	Nos	3		₹	-



RFQ No.: 4100065975

73	Supply & Erection, testing & commissioning of Outdoor mounting type LTCT Operated DTR Metering box made of SMC , dust and moisture vermin, weather proof with degree of protection ,3-Phase, 4-Wire CT Operated (200/5 A)Fully Static AMR Compatible Tri-vector Energy Meter, Accuracy Class 0.5S for Distribution Transformer fitted with Double Chamber Meter Box(As per DISCOM) along with Kiosk fitted with 4 nos. Resin Cast LTCT (Ring Type) of A PVC pipe double compression brass cable glands, Lugs ,Complete etc. as required	Nos	6		₹	-
74	Supply & Erection, testing & commissioning of Outdoor mounting type LTCT Operated DTR Metering box made of SMC , dust and moisture vermin, weather proof with degree of protection ,3-Phase, 4-Wire CT Operated (500/5 A)Fully Static AMR Compatible Tri-vector Energy Meter, Accuracy Class 0.5S for Distribution Transformer fitted with Double Chamber Meter Box(As per DISCOM) along with Kiosk fitted with 4 nos. Resin Cast LTCT (Ring Type) of A PVC pipe double compression brass cable glands, Lugs ,Complete etc. as required	Nos	10		₹	-
75	Supply & Erection, testing & commissioning of Outdoor mounting type Metering box (Double comp) made of MS sheet of thickness Not less than 2 mm CRCA, (H*L*W=600*500*250) sheet/DISCOM Spec, dust and moisture vermin, weather proof with degree of protection along with inspection glass window for Meter reading	Nos	16		₹	-
76	Supply & Installation Energy Meter 3Ph Whole current 10-60A, CMRI Compatible 0.5s Accuracy class	Nos	2		₹	-
77	Supply & Installation prodigy Energy Meter in build CT, 40-200A, CMRI Compatible 0.5s Accuracy class	Nos	2		₹	-
78	Supply & Installation of 125 A 4 pole Isolator(MCCB)	Nos	6		₹	-



RFQ No.: 4100065975

79	ELEC,Supply & Erection testing & commissioning of 200 A 4 pole Isolator(MCCB)25 kA make: Siemens Schneider L & T & C&S	Nos	2		₹	-
80	Supply & Installation of 250 A 4 pole Isolator(MCCB)	Nos	4		₹	-
81	Supply & Installation of 400 A 4 pole Isolator(MCCB)	Nos	1		₹	-
82	8 SWG GI wire	KG	50		₹	-
83	S&I of Danger Board with clamp as per Discom Sepc(English & Local Language)	EA	25		₹	-
84	S&I of anti-climbing devices (barbed wire), as per Discom Sepc	KG	70		₹	-
85	Supply & Installation of Fire Extinguishers 5 KG As per Applicable IE rule (DCP): Installation /Mounting with Bracket and required Hardware is in S&I Scope.	Nos	8		₹	-
86	Supply and installation of Electrical insulated Rubber mat Thickness- 2mm and 3 mm near electrical Equipments 11/33 KV rated for HT Installation Unit Of measurement of this Line Item is "Square Meter"	Sqm	30		₹	-
87	Supply & Installation of sand bucket with Hut type Stand as per DISHA norms , Supply rates includes following item . 1) Hut type Stand with red color coated suitable for hang the 4nos Sand Filled Buckets. 2)'Sand Buckets size 10kg Volume with Stands filled Double coated Red Colour Paint as per safety industrial Standard /DISHA norms 3) unloading of consignments, shifting of the same whenever required at designated place	Nos	4		₹	-
88	Supply & installation of CPR instruction board with both English & local language	Nos	4		₹	-
89	Supply & Installation of Sub-station protective fencing with necessary angle chhanel, GI wire mesh, Nut-Bolt, Washer complete, with door having locking arrngment, including painting by red oxide, aluminium paint , blue anti corrosive paintof approved quality as reqd.as per IS including supply of all materials.	Sqm	80		₹	-

Property of TPC – Not to be reproduced without prior written permission of TPC.



RFQ No.: 4100065975

90	Site survey for Power feasibility and submitting to Project Manager(SLD, nearest power Source,route etc.) as per format provided by TPEVCSL	Nos	16		₹	-
91	Liasoning Service for power arrangement of 0-25 kW	AU	1		₹	-
92	Liasoning Service for power arrangement of 26-50 kW	AU	1		₹	-
93	Liasoning Service for power arrangement of above 50-100 kW	AU	4		₹	-
94	Liasoning Service for power arrangement of above 100-200 kW	AU	10		₹	-
95	Liasoning Service for power arrangement of above 200-500 kW	AU	6		₹	-
96	0 to 100 kW, EI Liasoning: drawing preparation, site visit, follow up & NoC/approval from EI	AU	6		₹	-
97	100-200 kW, EI Liasoning: drawing preparation, site visit, follow up & NoC/approval from EI	AU	10		₹	-
98	200-500 kW, EI Liasoning: drawing preparation, site visit, follow up & NoC/approval from EI	AU	4		₹	-
99	HDD for Road, track crossing for laying of Cable, earthing at both the end	Meter	10		₹	-
100	Miscellaneous	Nos	1		₹	-
	Total Package cost (Rs.)					₹ 0
	GST @ 18%					₹ 0
	Total cost incl. GST					₹ 0

NOTE:

- Bidder must include total cost in the above price bid. NO separate payment shall be applicable for OPE, Travel, Stay, F&B, Stationary, Training, etc.
- The bidders are advised to quote prices strictly in the above format and for all the line items as mentioned above. Failing to do so, bids are liable for rejection.
- The bidder must fill each and every column of the above format. **Mentioning "extra/inclusive" in any of the column may lead for rejection of the price bid.**

Property of TPC – Not to be reproduced without prior written permission of TPC.



RFQ No.: 4100065975

- No cutting / overwriting in the prices is permissible.
- The unit price to be indicated in col. No. D should be exclusive of taxes & duties which are to be indicated in separate columns meant for the purpose.

CONFIDENTIAL



RFQ No.: 4100065975

ANNEXURE II
Technical Specifications/Scope of Work
Scope of Work & Service Level Agreement

Scope of Work for Power Infrastructure development for EV Charging Stations

Scope of Work:

Tata Power EV Charging Solutions Ltd (TPEVCSL) has installed public EV charging station PAN India. The services are sought for developing electrical, civil infrastructure and commissioning of site including Discom & EI liasoning, Power Infrastructure, Charger infrastructure as per site requirement. The detailed scope of work is provided below:

Liasoning Scope:

1. Preparation of the statutory documents as required by local and state electricity board.
2. Submission of the application online & physically with supporting documents to concern department.
3. Vendor shall ensure to apply new connection under EV tariff category only.
4. Arranging site visits with the concern authorities and make them understand the requirement and feasibility.
5. Obtaining estimation/demand note and submitting it to TPEVCSL for payment.
6. Ensuring payment to the department and taking the approval for new connection.
7. Ensuring installation of all the required equipment such as MCB, RCCB, Cabling & Energy Meter by the Contractors.
8. Inspection and charging of meter.
9. The scope of vendor shall also include collection of all supporting documents like No Object certificate (NOC), Ownership proof, Sale deed, Lease deed, Property paper, electricity bill and any other document as required by Discom from Location partner at no extra cost.
10. It is the responsibility of vendor to get generated first bill after energization of new connection meter & submit the same to TPEVCSL.
11. TPEVCSL shall make the payment of Discom estimate/demand note after getting the authentic documents only.
12. Getting EI approval wherever required. Preparing drawing, sketch submission to EI, making application for EI approval, rectify all EI observations etc.
13. Site feasibility Survey: Carry out site survey along with Discom official to get the feasibility of Power connection like, loading of existing DTR, new DTR requirement, distance of nearest feeder, RoW issue etc. The site survey report shall be submitted in the format provided by TPEVCSL.

(Note: The payment for site survey is one time & applicable to check power feasibility only if this survey is conducted before charger installation or before making formal application. This payment is not applicable for the site survey or site visit carried out after making applications for sites allocated for making application directly & getting new connection under liasoning. After making applications,



RFQ No.: 4100065975

only liasioning charges shall be paid as per existing terms & conditions and no other charges shall be paid).

Supply & Services Scope:

1. Arranging technical survey and site visits with DISCOM officials for feasibility check and electrical network requirement. Preparation of the statutory documents as required by local electricity office and state electricity board.
2. Supply & delivery of major materials (Distribution Transformer, Conductor, HT XLPE cable, LT cable, AB Cable & Energy Meters) loading of equipment/materials from their Stores, shifting to site, re-route, storage, erection, testing and commissioning.
3. Supply, Erection, Testing & Commissioning of materials as per BOQ including erection, testing & commissioning of materials as required for the job shall be as per DISCOM/TPEVCSL specifications & guidelines.
4. The Energy meters shall be provided by DISCOM from their stores. However, in some special cases, the contractor may be required to provide energy meter. If meter is required to be provided by contractor same need to be get tested from concerned DISCOM as per DISCOM procedure. The contractor shall also ensure suitable provisions in DT meter panel, feeder meter panel, consumer board for fixing of these meters as per requirement.
5. All the material supplied by the contractor should comply with the relevant Indian standards and DISCOM approved drawing & specifications.
6. Execution of all works shall be carried out as per DISCOM/TPEVCSL scope of works and approved by Project Manager.
7. All Steel structure shall be hot dip galvanized wherever required as per relevant Indian Standard/DISCOM Requirement.
8. It will be contractor's responsibility to facilitate in getting permissions/clearance (if required) of various agencies like, Corporation, local Govt. authorities, Road owning agency, forest, railways, residential complexes, any other agency, Electrical inspector clearance etc. as and when required. The statutory permission charges as demanded by these agencies shall be borne by Tata Power EV Charging Solutions Ltd on receipt of demand note given by agency.
9. It will be contractor's responsibility to execute the work, drawings, testing and any other certification as per DISCOM's requirement and satisfaction.
10. Contractor shall co-ordinate & follow up with the concerned DISCOM/authority office or any other agency for all related work from drawing clearance to erection, testing, commissioning till the charging of meter i.e commencement of power supply.
11. Cable provided shall be Fire retardant and should be IS standard as per Discom/TPEVCSL approved make.
12. Contractor shall complete the job within the timeline as specified by TPEVCSL, concerned DISCOM authorities.
13. Tata Power EV Charging Solutions Ltd shall not be responsible for any re-work or rejection of material by concerned DISCOM due to poor quality of work or material or specification & all cost towards such rework, material rejection shall be borne by contractor.
14. Contractor shall be responsible for repairs/replacement of material, attend defects and related services within guaranty, warranty period and also during the period as specified by Discom/as per agreement executed with Discom for Infra work under supervision basis. Any

RFQ No.: 4100065975

issue related to the same within above any of mentioned period shall be attended by contractor without any cost to Tata Power EV Charging Solutions Ltd.

15. Contractor shall provide all the relevant documents as required or asked by DISCOM, TPEVCSL. Contractor shall provide the SLD, guaranty/Warranty certificate, Purchase details, and Type test report, Make & model of Transformer, Cable, LT Panel & other supply items etc.
16. The payment will be made as per the actual quantity measured on site & verified by TPEVCSL engineer.
17. Any deviation in specification/material requirement/quantity from DISCOM or Tata Power EV Charging Solutions Ltd specification/requirement, Contractor shall take consent/approval from the Tata Power EV Charging Solutions Ltd /DISCOM.
18. Vendor to adhere to timelines for delivery & Installation as provided by TPEVCSL
19. Vendor shall conduct site survey & feasibility analysis & prepare civil & electrical layout with proper demarcation of LT Panel, SLD of Cable laying, Parking areas and chargers with skilled person along with TPC representative. Vendor to fill the survey form in TPEVCSL approved format with necessary information within given timeline for feasibility check and submit to TPEVCSL for further action. Turn-around time for Site survey shall be shared with bid document.

Information to be obtained during survey but not limited to,

- Identification of Power Source.
- Identification of Charger location & Parking lot. Checking for easy access of charger for EV operator.
- Finding Scope of Civil work for pedestal, concrete break & back fill etc. as applicable to site. Scope to be approved by TPCL.
- Identification of Earthing point.
- Measurement of Power Cable and earth cable length.
- Location of LT Panels, Distribution Box/ MCB Box etc.
- Finalization of Cable Route. Finalizing scope of activity for cable laying, Installation Earthing etc.
- Feasibility of Construction of earth-pit, nos. of earth pit will vary as per site condition.
- Vendor to intimate & take permission for any applicable clearance/approval process from TPC representative before starting work at site.
- Vendor has to arrange for light weight structures prefabricated for shed works. Design sketch to be submitted for approval.
- Vendor to ensure deployment of skilled & trained resources for the survey work.
- Coordination with other OEMs/Discom team for multiple chargers or new meter at site as per site condition.
- Vendor has to comply to timelines for survey & its report submission within 1 to 2 days after awarding the PO.
- Vendor will be also engaged into power connection liasoning work with DISCOM including infrastructure work up to DISCOM metering point.



RFQ No.: 4100065975

Tools, Tackles , Safety Apparels & Others:

Vendors are required to procure and maintain necessary tools required for carrying out the required work, Generator set for lighting if work extended in night, Scale for checking earth pit depth, Traffic Signals company, Toolbox Talk Register, Ladders, Pliers, and such other materials as may be required in adequate quantities for the work. The service worthiness of all these tools will be certified by Tata Power site engineer or supervisor before start of execution and if not satisfactory the vendor will not be allowed to work.

Protection and safe custody of these materials will be vendor's responsibility. The vendors are advised in their own interest to ensure the materials while being stored by them against theft, pilferage and damage due to any cause whatsoever. Any loss in this regard shall be made good by the vendor.

All the tools required for execution of job will have to be supplied by vendor. Vendor's tools will have to be declared at the gate with proper challan and certified by the gate security personnel to enable issue of exit gate pass after the job is completed. It may not be possible to issue exit gate pass for the equipment in the absence of these documents. The vendor shall take his materials outside the Company's premises with valid gate passes only.

Vendors should carry out Job Hazard analysis for the site and take the necessary precautions. For working in areas other than operational areas, vendors should ensure that non-operational area work permit is obtained from the concerned site engineer and it is validated everyday till the completion of work.

Vendors should use Standard PPEs like proper coloured helmets, safety shoes, gumboots with toecaps, safety belts, etc. as per the site requirements. The vendor shall make his own arrangements for transporting all material required for the work, within the premises of the Company.

In case of working on live system, Tata Power's site engineer/supervisor will identify the live equipment on which job needs to be carry out. After obtaining necessary outages and confirming the system is not charge, he will hand over the same to vendor for further work. The identified equipment / system will be marked with a red tape and the vendor will be issued work permit, authorizing him to start the work.

In case of the work in operational area, Vendor will take extreme care to avoid any occurrence and he will make his manpower aware of the safety hazards.

Supervision:

The vendor shall post full time, a qualified supervisor possessing the knowledge of and capable of controlling all aspects of the activities entrusted to the vendor. The supervisor shall co-ordinate with our site engineer in respect of all activities pertaining to the work. The vendor will employ skilled worker & will ensure their timely refresher training & certifications.

Safety:

Vendor shall use of all PPE's and safety apparels such as Helmets, safety shoes, hand gloves, full body harness, ladders in proper condition. Availability of fire extinguisher is mandatory.



RFQ No.: 4100065975

All the tools and tackles should have necessary insulation on their handle. Vendor shall use the tools approved by Tata Power, manmade tools shall not be permitted at site.

All statutory requirements such as ESIC/EPS/PF/ Insurance coverage for working personnel should be fulfilled by vendor before commencement of job.

Vendor shall follow the safety terms & conditions mentioned in Vendor Safety Code of Conduct & shall submit all documents as per Code of Conduct.

Vendor shall take all necessary precautionary measures while executing jobs at public places or any site and will not cause any damage to consumer property or other public utilities such as cables, gas line and water lines etc.

The Vendor shall deploy safety officer as mandated in the Project safety Plan.

The vendor shall provide orientation/induction training (TPSDI Training) to his entire Work force prior to deploying them on the job & submit the records to Tata Power safety officer on monthly basis.

The Vendor shall conduct daily toolbox meetings & attend safety meetings as per the requirements of the Project safety plan.

The Vendor shall ensure proper housekeeping at the work sites; ensure segregation of waste at prior identified locations.

The Vendor shall thoroughly assess the work scope, properly understand the hazards and risks associated with the job and carry out risk mitigation measure.

The Vendor shall carry out proper safety planning for the work scope involved, which includes but not limited to proper access, lay down areas, storage areas, waste disposal, movement of manpower and equipment, inspection schedules of tools, PPE, gas cylinders etc.

The Vendor shall ensure deployment of skilled and competent personnel for RMU/Conventional Transformer heavy equipment erection, Fabrication of MS, welding, equipment operators, fabricators, cable laying & termination, electricians etc.

The Vendor shall obtain work permits from Tata Power prior to starting the job.

The Vendor shall ensure that all of his workforce working at heights are specifically trained and have been medically certified.

The Vendor shall ensure that their workforce shall use proper scaffolds of approved quality and not using temporary work platforms.

Vendor shall ensure that his entire workforce is provided with approved PPE such as



RFQ No.: 4100065975

Gum boot with steel toe, safety shoes, helmet, reflective jacket, leather gloves etc. If vendor fail to provide, Tata power provide the PPE & will debit the PPE amount + 20% extra from the bill.

The Vendor shall comply with the Safety, Health & Environment requirements stated in Tata Power safety plan.

Vendor shall provide a detailed breakup of his estimate for compliance to safety as per the requirements of the Project Safety Plan.

Vendor shall report the unsafe act/ condition/ near miss to Tata power. Proactive reporting will be rewarded as per Reward & recognition policy for vendors.

Any safety violations shall be treated as per the consequence management policy.

Vendor shall submit the monthly safety report containing man-days worked safety training record, incident statics to Tata Power before 5th of every month.

Vendor shall provide the drinking water to his workforce during the work & test report of drinking water shall be submitted to Tata power on every quarter.

Vendor shall provide first aid box & fire extinguisher (type ABC 5kg) at site.

Vendor shall conduct an emergency mock drill at site once in a month & submit the mock drill report to Tata Power. Vendor shall adopt any other safety instructions given by Tata Power on time to time.

Vendor shall comply with safety item like rubber mat, Fire extinguisher, Respiratory Chart, Respiratory Artificial, Display Board (Do's & Don'ts), Energy Flow Diagram (EFD), SLD, VMS, Safety hand gloves, Safety Jacket, Face shield etc.

Measurement of Work:

Vendor & TPEVCSL shall jointly measure the actual quantities of work executed against each line-item w.r.t BOQ, as per standard mode of measurements, within a week of completion of work, & field measurements shall be duly approved by TPEVCSL. Payment shall be made as per actual quantity measured at site. Orders against this contract will be released by Corporate Contract/Respective Department. All future correspondence regarding this Order shall be addressed to the above-mentioned person. Also, bills to be submitted to the concerned Site Engineer / Project Manager.

Warranty/Guarantee Period:

Transformer & VCB = 5 years and 1 years on of all kinds of supply, installation & services from date of commissioning.

Special Conditions of Contract for Electrical Services:



RFQ No.: 4100065975

Vendor shall be prepared to work 24X7 depending on the nature of job as may be instructed by Site Engineer.

Payment will be made for the exact quantities of work carried out and verified by TPEVCSL Engineer.

The rates quoted shall be exclusive of GST & other taxes. While submitting the quotes & invoice, vendor shall indicate the component of GST in bid & invoice for statutory compliance.

The rates quoted shall include the charges for all materials (as applicable), services, supervisor, labour, tools, transportation, and all taxes other than GST & Service tax such as Octroi, Work Contract tax, Excise & all other applicable taxes. The rate quoted shall be for the complete finished work as specified.

The vendor shall ensure that all his employees including those of his sub-vendors shall be paid minimum wages of Uttar Pradesh State at a rate of 10% above the minimum wages specified by the Government from time to time.

No extra payments will be made for work to be carried out during nights.

The vendor must comply with the requirements of other organizations in whose premises the work may have to be carried out. No additional payment will be made for such compliances. Any financial penalties charged by such organizations for breach of their safety norms will be recovered from Vendors bills.

The vendor must fulfill all statutory requirements pertaining to Provident fund, ESIC/Workmen compensation in factory premises/areas outside factory premises respectively as applicable, payment of bonus, leave etc as per the prevailing Government norms.

Vendor shall provide appropriate & adequate safety PPE to all his employees. Over & above instructions from Site Engineer shall be followed for use of specific PPE.

The vendor shall possess IMS certification covering ISO Standards in QMS, EMS & BS OHSAS.

Vendor will have to adhere to Safety guidelines & safety advisories, issued by Tata Power Safety from time to time.

Tata Power has developed work instructions and procedures for carrying out activities safely. Vendor's supervisor needs to study these work instructions and complete site activities. Any deviation if required as per site condition, needs to be brought to notice of Tata Power's Engineer before start of activity well in advance.

Vendor needs to present Performance report for the job executed with other utilities.

Vendor needs to submit test reports / Guaranty cards for brought out items. If any unit like Board wiring DB is fabricated in workshop, type test reports needs to be submitted.

After erection, vendor shall assist to site engineer w.r.t manpower for Quality Inspections of the installation, Third Party Inspection, Electrical Inspector visit & charging of the installation.



RFQ No.: 4100065975

Material & services shall comply with respective specs, BIS codes etc. Site Engineer decision will be final & binding on all vendors.

After receipt of Material at site or from Tata Power's store, Vendor's supervisor shall inspect material w.r.t damages/missing items if any and shall communicate to Tata Power's engineer within 24 hrs., failing which the material provided by TPC shall be considered as "FIT FOR USE AT SITE".

Vendor shall make arrangements for drinking water to the people working at site.

Vendor shall issue photo I Cards to all his employees.

The vendor shall provide an undertaking that he shall follow all the statutory norms required for the work he will be executing with Tata Power Cos. Ltd.

The Vendor shall adhere to the time schedule provided by Tata Power.

Vendor should arrange potable DG set for Electrical Installation work which required electricity. Vendor should arrange sufficient Potable light arrangement during night time.

Manpower Deployment:

As per project schedule. However, no of resources for Project Manager, site supervisor, site engineer, Safety/Quality officer to be allocated for project site shall be as per site requirement/TPEVCSL.

Contactor Selection Criteria:

- **Technical Capabilities:**
The Vendor shall have experience of working with Utilities and jobs like installation & commissioning of RMU/Transformer, Laying of LT & HT cables, LT/HT line erection, Erection of Distribution Transformer, construction of civil foundation for Switchgears, construction of Discom Meter Room, construction of sheds, services for cable laying work, trenching, excavation at consumer premises, Utilities, on public roads & highways, (belonging to any Municipal Corporation, PWD, etc.), Installation of MCCB/Distribution Box, Earthing, Earth pit executing work etc. (Contactor should provide the PO copies or Work completion certificate etc.)
- **Electrical Contractor certificate/Licence:** Bidder shall have valid Electrical contractor certificate/Licence for the state.



RFQ No.: 4100065975

Deliverables:

Contractor shall execute & complete the Infra work along with WCR & EI approval, Meter installation, charging & commissioning of site as per following from date of PO/OLA or email confirmation to start the Infra work. Tata Power may levy Penalty/LD in case of delay.

SN	SLA	Target	Base document for imposing SLA	Penalties
1	Site survey & Making application after site allocation and providing requisite documents	Within 7 working days	Allocation of site with complete documents availability	5% of PO value in case of delay in project commissioning.
2	Get Demand Note from Discom	Within 30 days of date of application	Date of application, Demand note issued date by Discom/receipt date by TPEVCSL	
3	Installation, energization of Meter & commissioning of site	2 months from date of Demand Note/Estimate	Meter indent document/installation report	
4	Share project schedule along with Resource	Within a week of allocation of OLA		

Note: If Delay is attributed due to Discom then vendors shall provide the concerned documents towards the same.



Gourav EnerGen India (P) Ltd.

{An ISO 9001:2015, ISO 14001:2015 and SANGAM Group Company}

www.gouravenergen.co.in



GENERAL TECHNICAL PARAMETERS 415V AC LV Distribution Panel with 630A FP MCCB

	GTPs for MCCB	630A MCCB	GEIPL Provided
	Vender Address and contact details		M/s Gourav Ener Gen India Pvt. Ltd. Administrative Block, Industrial Estate, C. B. Ganj Bareilly -243502 UP Mob. No.: 9359486426 Ph. No. 0581 - 2561527, 2561050
A	Ratings		
1	Ampere	630A MCCB	630A MCCB
2	Primary V	415V	415V
3	Phase	3 phases	3 phases
4	Frequency (Hz)	50Hz	50Hz
5	Ambient Temp C/Relative Humidity	50°C	50°C
6	Application	Outdoor	Outdoor
B	Enclosure		
1	Overall Limiting Dimensions W x D x H (mm)	To be provided by the bidder Minimum width 450 mm	550 (W) X 600 (D) X 1100 mm (H)
2	Gauge and material	16 Gauge M.S. Sheet	16 Gauge M.S. Sheet (1.6 mm)
3	Gland Plate Thickness		
4	Colour of Body	Powder Coated with Siemens Gray Shade No. 7032	Powder Coated with Siemens Gray Shade No. 7032
5	Protection grade of enclosure	IP 54	IP 54 with Fan & Filter
C	Bus Bar Size		
1	Phase Material Aluminium	2 X 40 X 10 mm	800A Al. Bus Bar (40X 10 X 02 Nos.) / Eq. (In Size/ Area) for 3 Phases. (As per Switchgear Designs)
2	Neutral Material Aluminium	2 X 40 X 10 mm	800A Al. Bus Bar (40X 10 X 02 Nos.) / Eq. (In Size/ Area) for 3 Phases. (As per Switchgear Designs)
3	Earth Material GI	1 X 50 X 6 mm	50 x 06 mm x 01 No. G.I. Earth Strip
4	Clearance B/ w Ph. to Ph.	20 mm	20 MM Min. as per Switchgear Designs
5	Clearance B/ w Ph. to N.	20 mm	20 MM Min.
D	MCCB		
1	Make	Schneider/ Siemens/ ABB	Schneider/ Siemens/ LK/ ABB
2	Rating(kA)	36kA	36kA
3	Pole/ Phase	FP	FP
4	Rating	630A MCCB	630A MCCB
5	Type	Manual Fixed	Manual Fixed
E	Indication		
1	Make	Schneider/ C&S/ Eq.	Reputed
2	RYB Phase Indicators with Control Fuses	Yes Provided	Yes Provided
F	Metering		
1	Make	Selec/ Eq.	Selec/ Secure/ LK/ Sch/ Eq.
2	Multifunction Meter without RS485 communication Port	Flush Mounting; Size - 96x96MM; Acc. Cl. 1.0; Parameters: V, A, F, etc.	Provided



Bills of Materials [BOM] - Switchgears, Controlgears, Instruments, etc.

S.#	ITEM DESCRIPTION							Qty	UOM
Component Name/ Description	MAKE	Item Rating/ Size	Ph./ Pole	kA, etc.	Type	Remarks			
Main Incomer	----	----	3Ph.	415V AC	----		1	Set	
1 MCCB with Thermal Magnetic Release having OL & SC Protections	Schneider/ Siemens/ LK/ ABB	630A	FP	Icu=36kA	Manual Fixed		1	Set	
2 MCCB Accessories - Spreader Links, Phase Barriers, Extended Rotary Handle etc.	Schneider/ Siemens/ LK/ ABB	630A	FP	----	----		1	Set	
3 Multifunction Meter without RS485 Port; Flush Mounting; Size - 96x96MM; Acc. Cl. 1.0; Parameters: V, A, Hz, PF	Selec/ Secure/ LK/ Sch./ Eq.	-/5A	3Ph-4W	230V AC	Digital LCD Display		1	Set	
4 Current Transformers for Metering; BPL Ring Type; CTR:: -/5A	EnerGen/ Eq.	600A	15VA	Cl. 1.0	Tape Wound		3	Nos.	
5 Polyamide CT Shorting Links - Disconnecting (Dropout) Type	Reputed	4.00Sq.MM	SP	----	Screw Clamp Type		3	Nos.	
6 RYB Phases Indication Lamps	Reputed	22.50MM	SP	230V AC	Integral LED Type		1	Set	
7 Control Fuse Base with HRC Fuse Link	C&S/ HPL/ Havells/ Eq.	2A	SP	230V AC	NS Type		4	Nos.	
8 Cooling Fan with Air Filter	Reputed	6"	SP	230V AC	ABS Body		1	Set	
9 Time Switch (220V AC) - for Cyclic operation of Cooling Fan	Selec/ Havells/ GIC/ Eq.	6A	SP	230V AC	Dial Type		1	No.	
10 Control Fuse Base with HRC Fuse Link	C&S/ HPL/ Havells/ Eq.	2A	SP	230V AC	NS Type		1	No.	

This drawing is conceived and designed at Gourav EnerGen India (P) Ltd. [GEIPL], Bareilly (UP) - INDIA. It is the property of GEIPL & therefore, it must not be copied, used or reproduced without the prior consent of the proprietor.

CIN - U31300UP1994PTC016434
Website: www.gouravenergen.co.in

All Dimn. are in MM.		GEN	BOM	1/ 1	GAD	SYM	SLD	CCD	TBD	M/s GOURAV ENERGEN INDIA (P) LTD. <i>(An ISO 9001:2015 & SANGAM Group Company)</i>		
SCALE	NTS											CLIENT M/s Tata Power Company Limited.
DATE	04112025	5112025	Address Mumbai		Project/P.O. TPCLMUM-1-251104A01		Panel Title 415V AC LV Distribution Panel with 630A FP MCCB					
DRN	SS	SS										
CHD	VBS	Dr#										
APPR	VBS	Job #	20251104A-0001									

This drawing is conceived and designed at Gourav EnerGen India (P) Ltd. [GEIPL], Bareilly (UP) - INDIA. It is the property of GEIPL & therefore, it must not be copied, used or reproduced without the prior consent of the proprietor.

CIN - U31300UP1994PTC016434
Website: www.gouravenergen.co.in

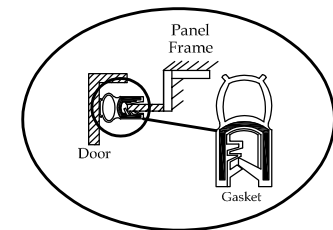
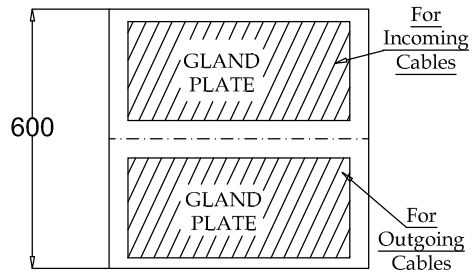
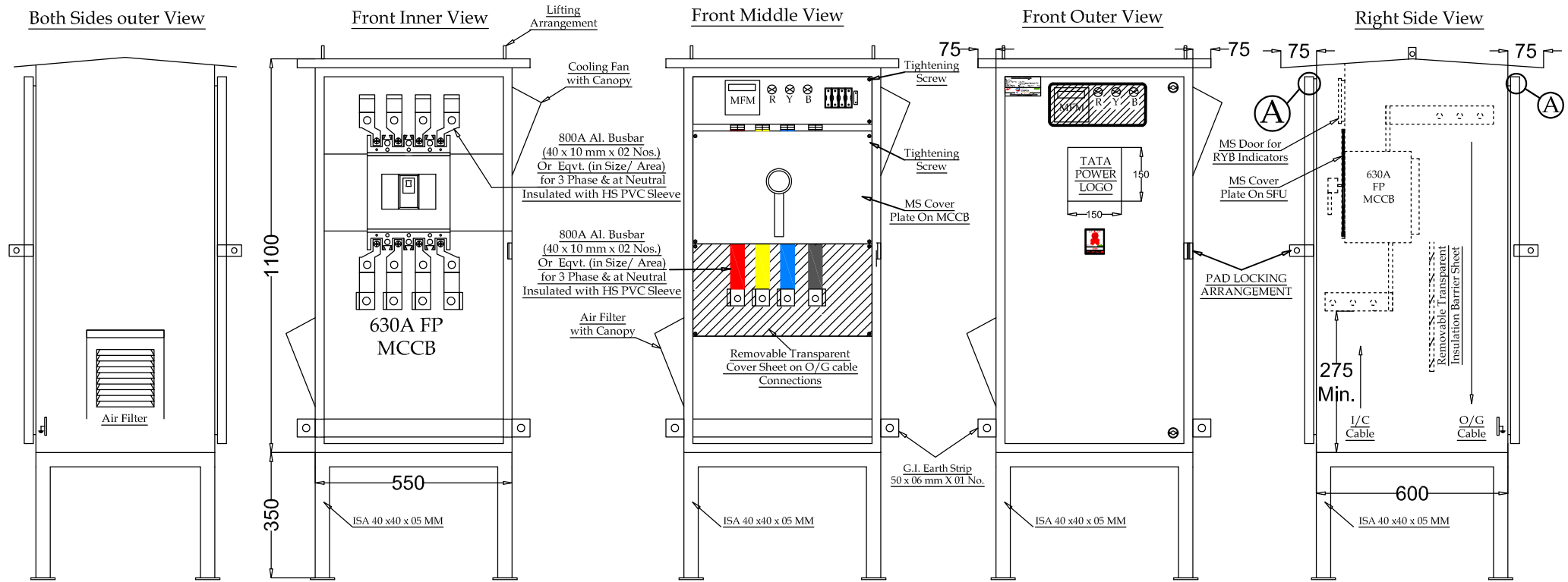

Detail's 'A'

Note:-

- 1-Min. Clearance Between Phase to Phase - 20 MM
- 2-Min. Clearance Between Phase to Neutral - 20 MM

All Dimn. are in MM.		GEN	BOM	GAD	1/2	SYM	SLD	CCD	TBD	M/s GOURAV ENERGEN INDIA (P) LTD. (An ISO 9001:2015 & SANGAM Group Company) Office : Administrative Block, Indl. Estate , Clutter Buck Gunj, Bareilly (U.P.) Landline : +91 - 581 -2561527, 2560082 Office Cellphone : +91 - 9149068638 Email : dct2_designs@gouravenergen.co.in
SCALE	NTS									
DATE	04112025/5112025	CLIENT	M/s Tata Power Company Limited.							
DRN	SS SS	Address	Mumbai							
CHD	VBS Drg #	TPCLMUM-1-251104A02	Project/P.O.							
APPR	VBS Job #	20251104A-0001				Panel Title	415V AC LV Distribution Panel with 630A FP MCCB			

This drawing is conceived and designed at Gourav EnerGen India (P) Ltd. [GEIPL], Bareilly (UP) - INDIA. It is the property of GEIPL & therefore, it must not be copied, used or reproduced without the prior consent of the proprietor.

CIN - U31300UP1994PTC016434
Website: www.gouravenergen.co.in

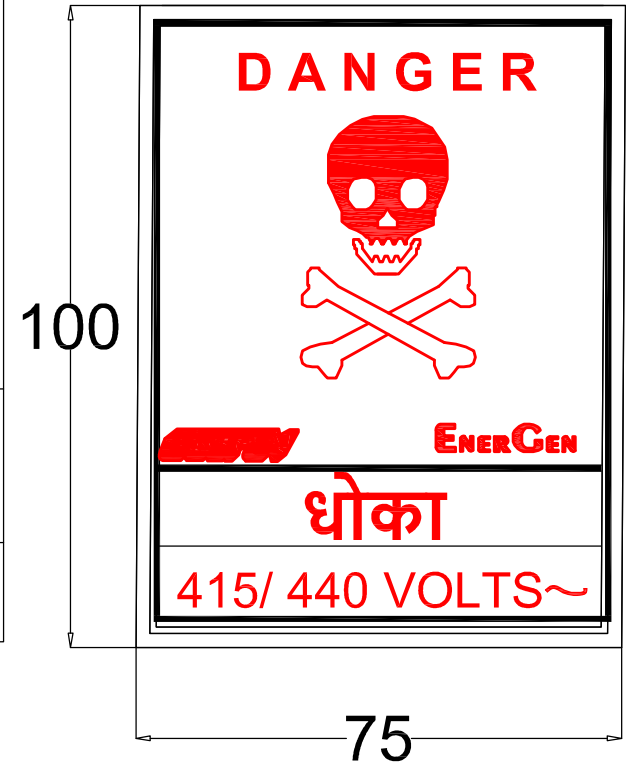
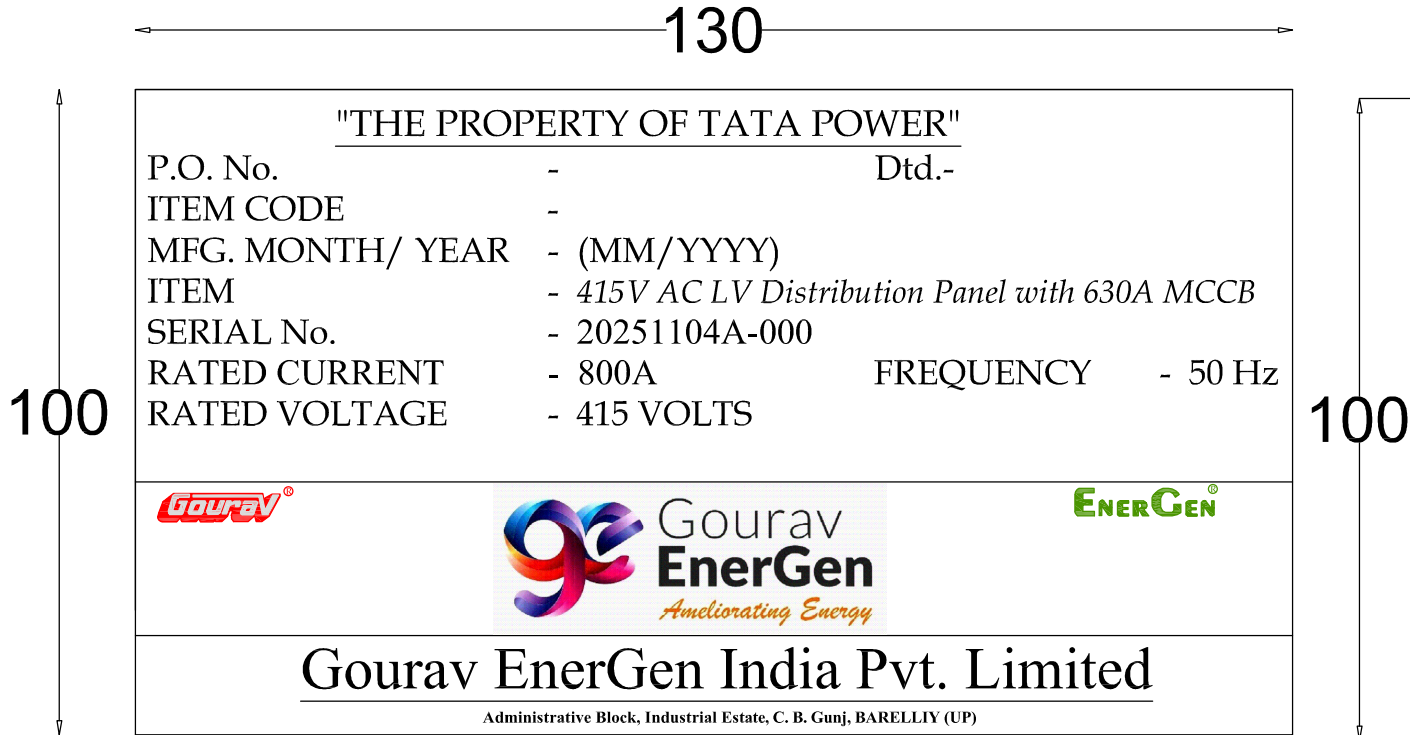

Colour Scheme For Panel Title Plate	
Font Colour	- White
Font Text Style	- Bold
Background Colour	- Black

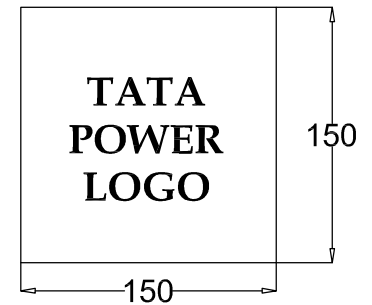

All Dimn. are in MM.		GEN	BOM	GAD	2/ 2	SYM	SLD	CCD	TBD	
SCALE	NTS									
DATE	04112025	515112025	CLIENT M/s Tata Power Company Limited.							
DRN	SS	SS	Address Mumbai							
CHD	VBS	Drq #	TPCLMUM-1-251104A03							
APPR	VBS	Job #	20251104A-0001							
Project/P.O.										

M/s GOURAV ENERGEN INDIA (P) LTD. <small>(An ISO 9001:2015 & SANGAM Group Company)</small>	
<small>Office : Administrative Block, Indl. Estate , Clutter Buck Gunj, Bareilly (U.P.) Landline: +91 - 581 -2561527, 2560082 Office Cellphone: +91 - 9149068638 Email: dct2_designs@gouravenergen.co.in</small>	
Panel Title	415V AC LV Distribution Panel with 630A FP MCCB

This drawing is conceived and designed at Gourav EnerGen India (P) Ltd. [GEIPL], Bareilly (UP) - INDIA. It is the property of GEIPL & therefore, it must not be copied, used or reproduced without the prior consent of the proprietor.

CIN - U31300UP1994PTC016434
Website: www.gouravenergen.co.in

S. No.	Symbol	Description	S. No.	Symbol	Description	S. No.	Symbol	Description	S. No.	Symbol	Description
1		Manually Operated Drawout type Air Circuit Breaker without Release	13		Electrically Operated Drawout type Air Circuit Breaker without Release	25		Manually Operated Drawout type Air Circuit Breaker with Release	37		Electrically Operated Drawout type Air Circuit Breaker with Release
2		Moulded Case Circuit Breaker with Release	14		Motor Protection Circuit Breaker	26		Switch Fuse Unit	38		Change Over Switch
3		Auxiliary Contactor	15		Power Contactor	27		Timer	39		Neutral Link
4		Indicating Light	16		Push Button	28		Illuminated Push Button	40		Capacitor Bank
5		Breaker Control Switch	17		Selector Switch	29		Core Balanced Current Transformer	41		Thermal Overload Relay
6		Push Button with 'NO' Element	18		Push Button with 'NC' Element	30		CT Shorting Link	42		kWh Meter with Comm. Port
7		Multi Function Meter	19		Multi Function Meter with Comm. Port	31		Electronic kWh Meter	43		Dual Source kWh Meter with Comm. Port
8		Ampere Meter	20		Volt Meter	32		Earthing	44		Cooling Fan
9		Under Voltage Relay	21		Over Voltage Relay	33		Reverse Power Relay	45		Master Trip Relay
10		AMF Relay	22		Alarm Annunciator	34		Control Transformer	46		Programmable Logic Controller
11		MCB	23		Control Fuse	35		APFC Relay	47		Power Factor Meter
12		Potential Transformer	24		Current Transformer	36		Bolt with washer	48		Pin Type Panel Lock

All Dimn. are in MM.			GEN	BOM	GAD	SYM	1/1	SLD	CCD	TBD	M/s GOURAV ENERGEN INDIA (P) LTD. <i>(An ISO 9001:2015 & SANGAM Group Company)</i> Office : Administrative Block, Indl. Estate , Clutter Buck Gunj, Bareilly (U.P.) Landline: +91 - 581 -2561527, 2560082 Office Cellphone: +91 - 9149068638 Email: dcl2_designs@gouravenergen.co.in
SCALE	NTS										
DATE	04112025	15112025	CLIENT	M/s Tata Power Company Limited.							
DRN	SS	SS	Address	Mumbai							
CHD	VBS	Dr#	TPCLMUM-1-251104A05	Project/ Site							
APPR	VBS	Job #	20251104A-0001	Panel Title	415V AC LV Distribution Panel with 630A FP MCCB						

This drawing is conceived and designed at Gourav EnerGen India (P) Ltd. [GEIPL], Bareilly (UP) - INDIA. It is the property of GEIPL & therefore, it must not be copied, used or reproduced without the prior consent of the proprietor.

CIN - U31300UP1994PTC016434
 Website: www.gouravenergen.co.in

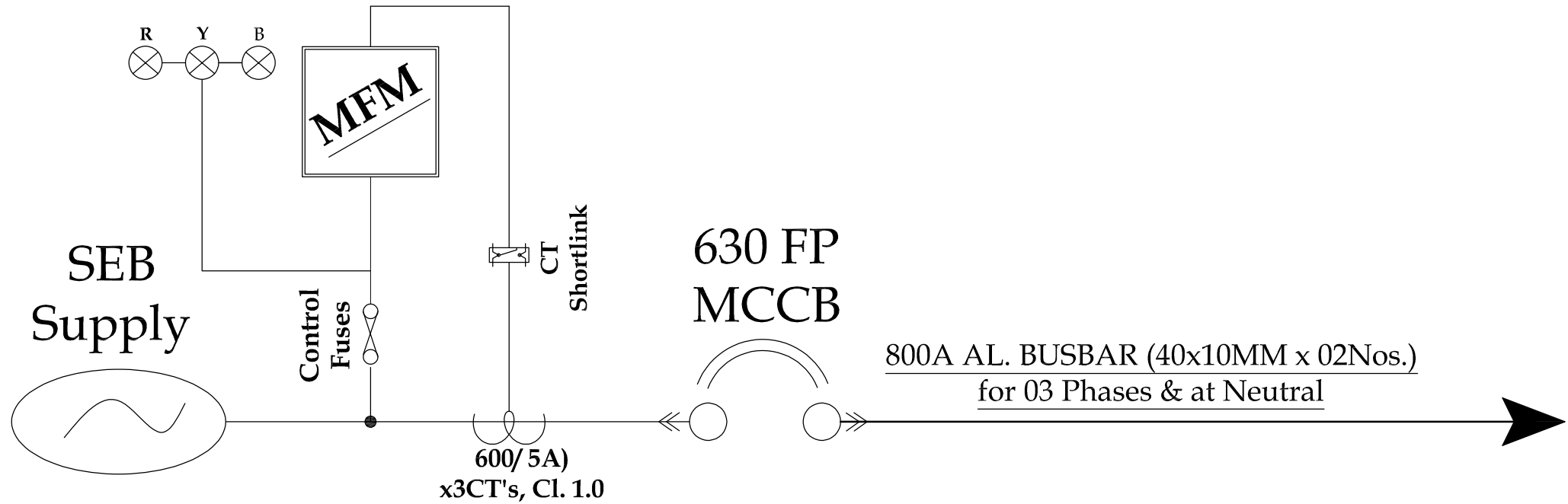

All Dimn. are in MM.			GEN	BOM	SYM	CCD	SLD	1/ 1	FDR	GAD
SCALE	NTS									
DATE	04112025	15112025	CLIENT		M/s Tata Power Company Limited.					
DRN	SS	SS	Address		Mumbai					
CHD	VS	Drg #	TPCLMUM-1-251104A05		Project/ Site					
APPR	VS	Job #	20251104A-0001							

M/s GOURAV ENERGEN INDIA (P) LTD. <i>(An ISO 9001:2015 & SANGAM Group Company)</i>	
Office : Administrative Block, Indl. Estate , Clutter Buck Gunj, Bareilly (U.P.)	
Tele-Fax: +91 - 581 - 2560082, 2561527 Phone: 3291383	
Email: geipl.design@gmail.com, gouravenergen@gmail.com	
Panel Title	415V AC LV Distribution Panel with 630A FP MCCB



Gourav EnerGen India (P) Ltd.

{An ISO 9001:2015, ISO 14001:2015 and SANGAM Group Company}

www.gouravenergen.co.in



GENERAL TECHNICAL PARAMETERS 415V AC LV Distribution Panel with 800A FP ACB

	GTPs for ACB	800A ACB	GEIPL Provided
	Vender Address and contact details		M/s Gourav Ener Gen India Pvt. Ltd. Administrative Block, Industrial Estate, C. B. Ganj Bareilly -243502 UP Mob. No.: 9359486426 Ph. No. 0581 - 2561527, 2561050
A Ratings			
1 Ampere		800A ACB	800A ACB
2 Primary V		415V	415V
3 Phase		3 phases	3 phases
4 Frequency (Hz)		50Hz	50Hz
5 Ambient Temp C/Relative Humidity		50°C	50°C
6 Application		Outdoor	Outdoor
B Enclosure			
1 Overall Limiting Dimensions W x D x H (mm)		To be provided by the bidder Minimum width 450 mm	700 (W) X 900 (D) X 1250 mm (H)
2 Gauge and material		16 Gauge M.S. Sheet	16 Gauge M.S. Sheet (1.6 mm)
3 Gland Plate Thickness			
4 Colour of Body		Powder Coated with Siemens Gray Shade No. 7032	Powder Coated with Siemens Gray Shade No. 7032
5 Protection grade of enclosure		IP 54	IP 54 with Fan & Filter
C Bus Bar Size			
1 Phase Material Aluminium		2 X 50 X 10 mm	1000A Al. Bus Bar (50X 10 X 02 Nos.) / Eq. (In Size/ Area) for 3 Phases. (As per Switchgear Designs)
2 Neutral Material Aluminium		2 X 50 X 10 mm	1000A Al. Bus Bar (50X 10 X 02 Nos.) or Eq. (In Size/ Area) for Neutral
3 Earth Material GI		1 X 50 X 6 mm	50 x 06 mm x 01 No. G.I. Earth Strip
4 Clearance B/ w Ph. to Ph.		20 mm	20 MM Min. as per Switchgear Designs
5 Clearance B/ w Ph. to N.		20 mm	20 MM Min.
D ACB			
1 Make		Schneider/ Siemens/ ABB	Schneider/ Siemens/ LK/ ABB
2 Rating(kA)		50kA	50kA
3 Pole/ Phase		FP	FP
4 Rating		800A	800A
5 Type		Manual Fixed	Manual Fixed
E Indication			
1 Make		Schneider/ C&S/ Eq.	Reputed
2 RYB Phase Indicators with Control Fuses		Yes Provided	Yes Provided
F Metering			
1 Make		Selec/ Eq.	Selec/ Secure/ LK/ Sch./ Eq.
2 Multifunction Meter without RS485 communication Port		Flush Mounting; Size - 96x96MM; Acc. Cl. 1.0; Parameters: V, A, F, etc.	Provided

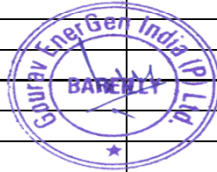

Bills of Materials [BOM] - Switchgears, Controlgears, Instruments, etc.

S.#	ITEM DESCRIPTION							Qty	UOM
Component Name/ Description	MAKE	Item Rating/ Size	Ph./ Pole	kA, etc.	Type	Remarks			
Main Incomer - 1		SEB Supply	----	3Ph.	415V AC	----		1	Set
1	ACB with μ P Based Release having OL, SC & EF Protections [LSIG for 3Ph-4W];	Schneider/ Siemens/ LK/ ABB	800A	FP	Ics=Icu= Icw=50kA	Manual Fixed		1	Set
2	Multifunction Meter without RS485 Port; Flush Mounting; Size - 96x96MM; Acc. Cl. 1.0; Parameters: V, A, Hz, PF	Selec/ Secure/ LK/ Sch./ Eq.	-/5A	3Ph-4W	230V AC	Digital LCD Display		1	Set
3	Current Transformers for Metering; BPL Ring Type; CTR:: -/5A	EnerGen/ Eq.	800A	15VA	Cl. 1.0	Tape Wound		3	Nos.
4	Polyamide CT Shorting Links - Disconnecting (Dropout) Type	Reputed	4.00Sq.MM	SP	----	Screw Clamp Type		3	Nos.
5	RYB Phases Indication Lamps	Reputed	22.50MM	SP	230V AC	Integral LED Type		1	Set
6	Control Fuse Base with HRC Fuse Link	C&S/ HPL/ Havells/ Eq.	2A	SP	230V AC	NS Type		4	Nos.
7	Cooling Fan with Air Filter	Reputed	6"	SP	230V AC	ABS Body		1	Set
8	Time Switch (220V AC) - for Cyclic operation of Cooling Fan	Selec/ Havells/ GIC/ Eq.	6A	SP	230V AC	Dial Type		1	No.
9	Control Fuse Base with HRC Fuse Link	C&S/ HPL/ Havells/ Eq.	2A	SP	230V AC	NS Type		1	No.

This drawing is conceived and designed at Gourav EnerGen India (P) Ltd. [GEIPL], Bareilly (UP) - INDIA. It is the property of GEIPL & therefore, it must not be copied, used or reproduced without the prior consent of the proprietor.

CIN - U31300UP1994PTC016434
Website: www.gouravenergen.co.in

All Dimn. are in MM.		GEN	BOM	1/1	GAD	SYM	SLD	CCD	TBD	M/s GOURAV ENERGEN INDIA (P) LTD.	
SCALE	NTS									<small>(An ISO 9001:2015 & SANGAM Group Company)</small>	
DATE	04112025	5112025	CLIENT M/s Tata Power Company Limited.					Office : Administrative Block, Indl. Estate , Clutter Buck Gunj, Bareilly (U.P.) Landline: +91 - 581 -2561527, 2560082 Office Cellphone: +91 - 9149068638 Email: dct2_designs@gouravenergen.co.in			
DRN	SS	SS								Address Mumbai	
CHD	VBS	Drg # TPCLMUM-1-251104E01		Project/P.O.					Panel Title 415V AC LV Distribution Panel with 800A FP ACB		
APPR	VBS	Job # 20250414A-0001									

This drawing is conceived and designed at Gourav EnerGen India (P) Ltd. [GEIPL], Bareilly (UP) - INDIA. It is the property of GEIPL & therefore, it must not be copied, used or reproduced without the prior consent of the proprietor.

CIN - U31300UP1994PTC016434
 Website: www.gouravenergen.co.in

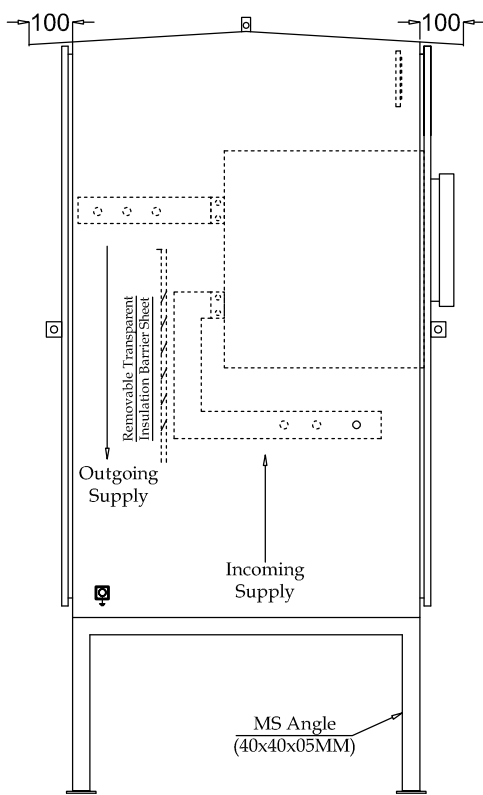

Both Side View

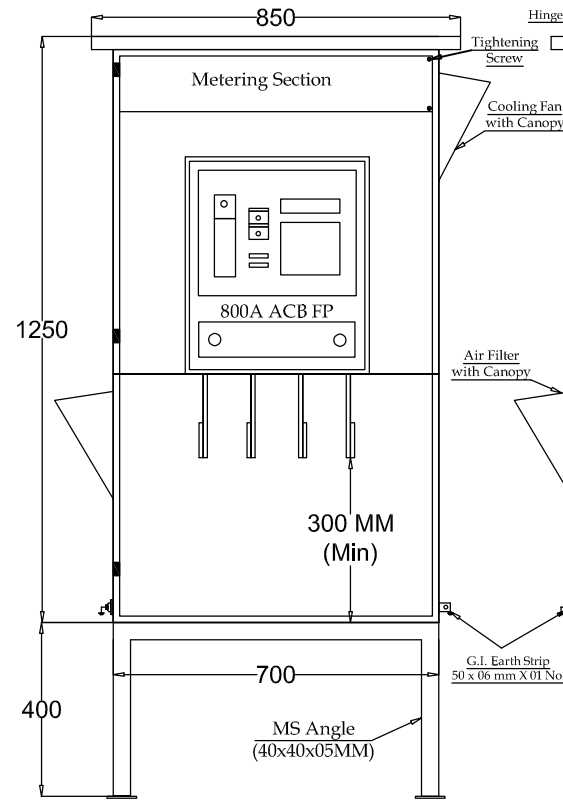

Front Inner View

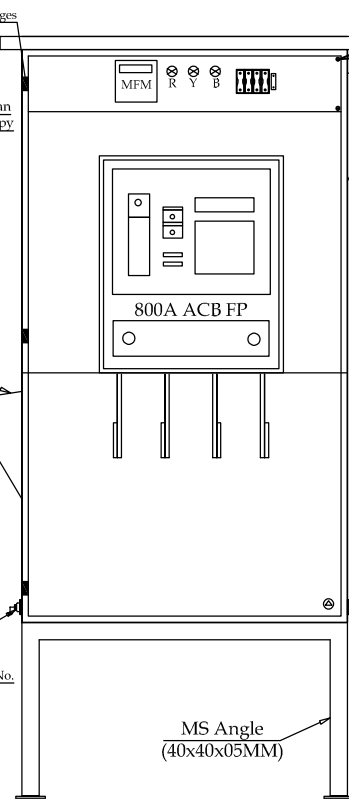

Front Middle View

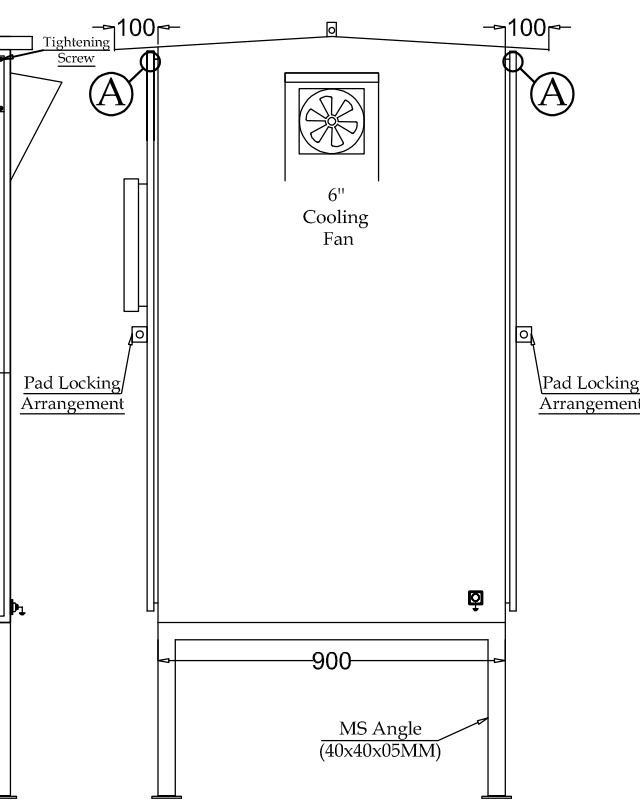

Right Side View

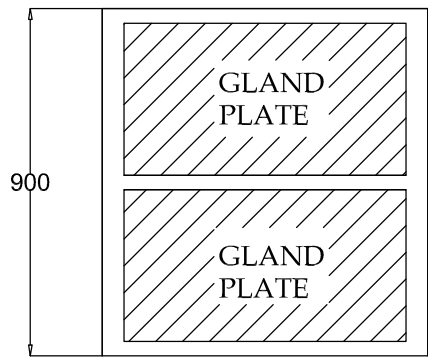

Bottom View

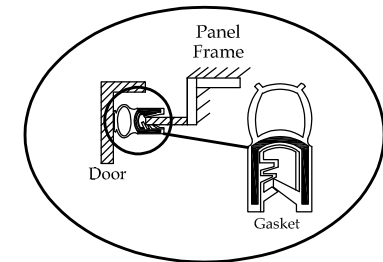

Detail's 'A'

All Dimn. are in MM.			GEN	BOM	GAD	1/3	SYM	SLD	CCD	TBD
SCALE	NTS									
DATE	04112025	15112025	CLIENT		M/s Tata Power Company Limited.					
DRN	SS	SS	Address		Mumbai					
CHD	VS	Dr#	Project/ Site		TPCLMUM-1-251104E02					
APPR	VS	Job #			20251104E-0001					

M/s GOURAV ENERGEN INDIA (P) LTD. (An ISO 9001:2015 & SANGAM Group Company)	
Office : Administrative Block, Indl. Estate , Clutter Buck Gunj, Bareilly (U.P.) Landline : +91 - 581 -2561527, 2560082 Office Cellphone : +91 - 9149068638 Email: dct2_designs@gouravenergen.co.in	
Panel Title	415V AC LV Distribution Panel with 800A FP ACB

This drawing is conceived and designed at Gourav EnerGen India (P) Ltd. [GEIPL], Bareilly (UP) - INDIA. It is the property of GEIPL & therefore, it must not be copied, used or reproduced without the prior consent of the proprietor.

CIN - U31300UP1994PTC016434
 Website: www.gouravenergen.co.in

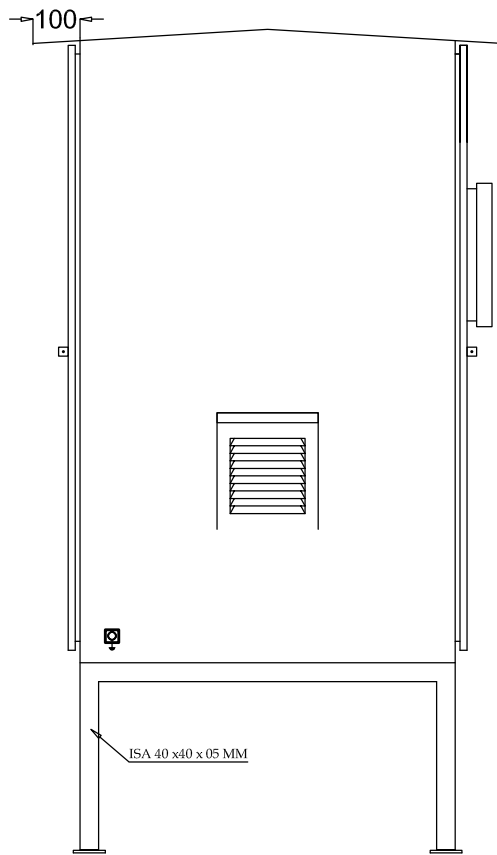

Left Side View

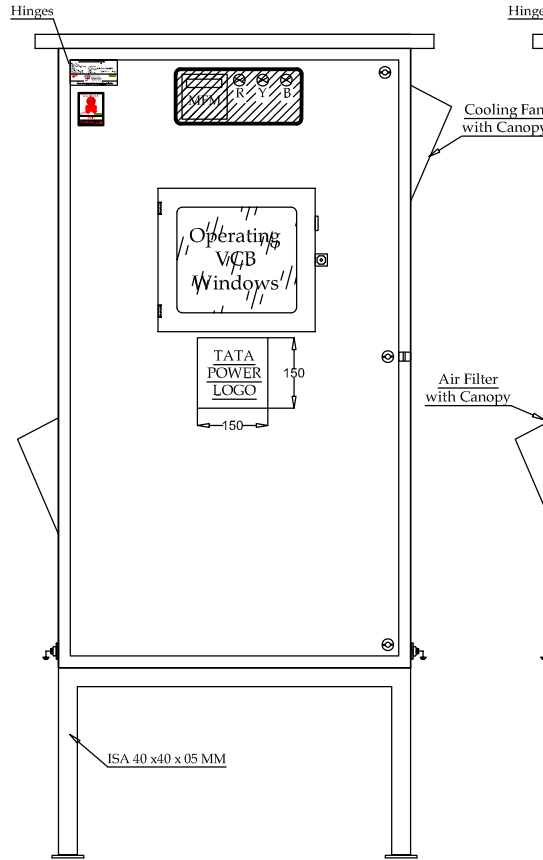

Front Outer View

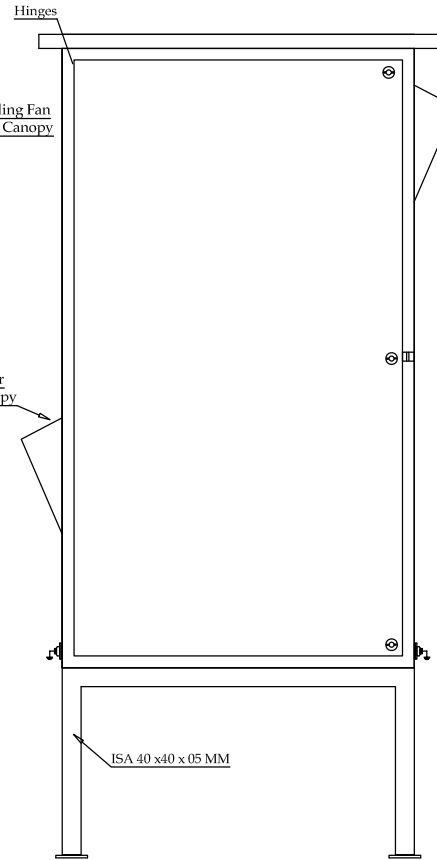

Rear Outer View

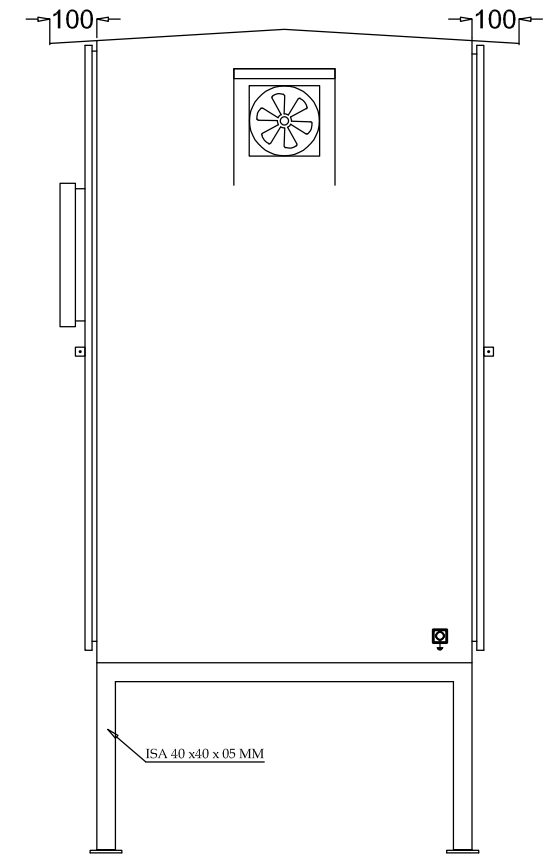

Right Side View

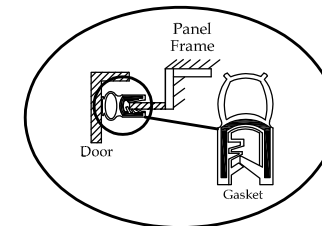

Detail's 'A'

All Dimn. are in MM.		GEN	BOM	GAD	2/3	SYM	SLD	CCD	TBD
SCALE	NTS								
DATE	04/11/2025	15/11/2025							
DRN	SS	SS							
CHD	VS	Dr#	TPCLMUM-1-251104E03						
APPR	VS	Job #	20251104E-0001						
CLIENT		M/s Tata Power Company Limited.							
Address		Mumbai							
Project/ Site									

M/s GOURAV ENERGEN INDIA (P) LTD.

(An ISO 9001:2015 & SANGAM Group Company)

Office : Administrative Block, Indl. Estate , Clutter Buck Gunj, Bareilly (U.P.)

Landline: +91 - 581 -2561527, 2560082 Office Cellphone: +91 - 9149068638

Email: dct2_designs@gouravenergen.co.in

Panel Title 415V AC LV Distribution Panel with 800A FP ACB

This drawing is conceived and designed at Gourav EnerGen India (P) Ltd. [GEIPL], Bareilly (UP) - INDIA. It is the property of GEIPL & therefore, it must not be copied, used or reproduced without the prior consent of the proprietor.

CIN - U31300UP1994PTC016434
Website: www.gouravenergen.co.in

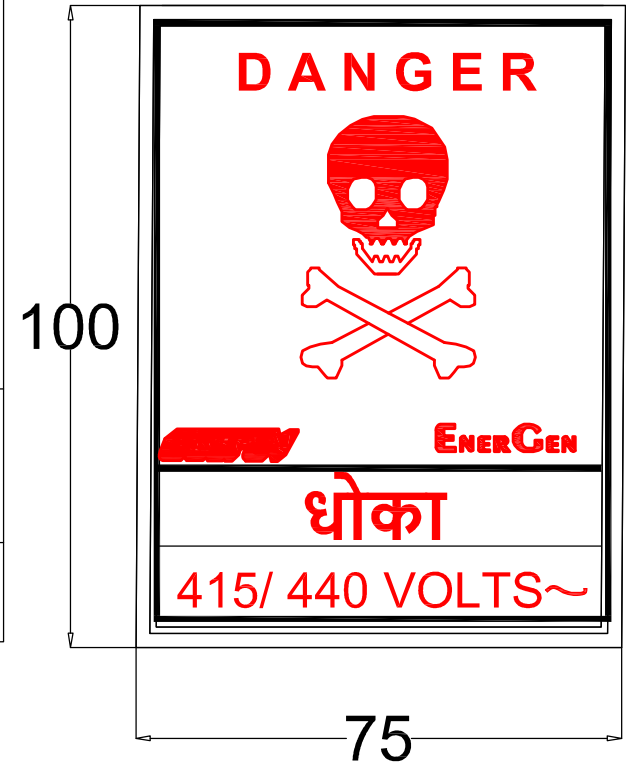
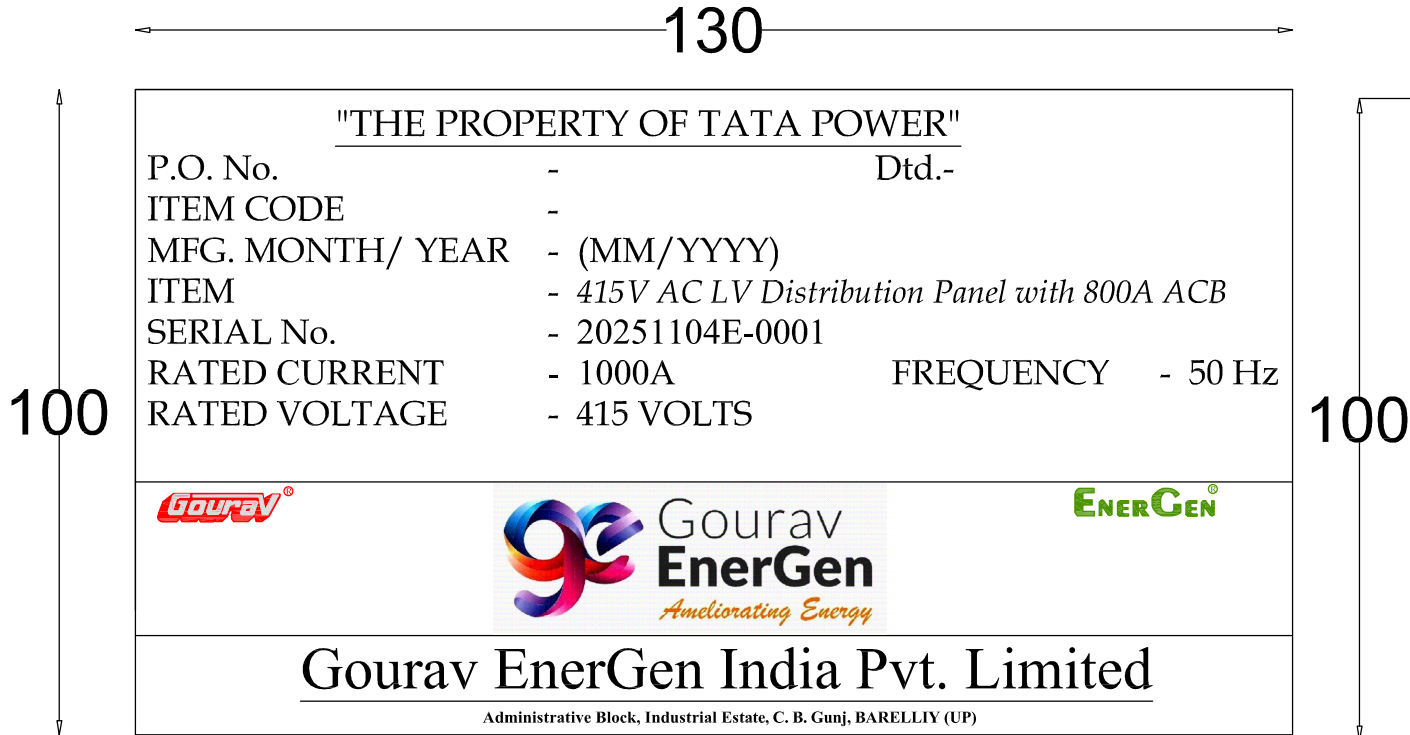

Colour Scheme For Panel Title Plate	
Font Colour	- White
Font Text Style	- Bold
Background Colour	- Black

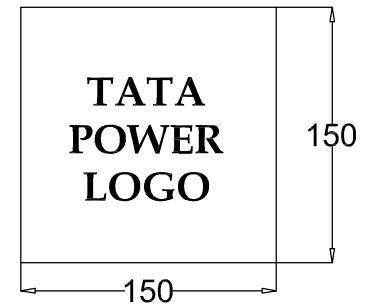

All Dimn. are in MM.		GEN	BOM	GAD	3/3	SYM	SLD	CCD	TBD	
SCALE	NTS									
DATE	04112025	515112025	CLIENT M/s Tata Power Company Limited.							
DRN	SS	SS								
CHD	VBS	Drq #	Address Mumbai							
APPR	VBS	Job #								
			Project/P.O. TPCLMUM-1-251104E04							

M/s GOURAV ENERGEN INDIA (P) LTD.	
<i>(An ISO 9001:2015 & SANGAM Group Company)</i>	
Office : Administrative Block, Indl. Estate , Clutter Buck Gunj, Bareilly (U.P.)	
Landline: +91 - 581 -2561527, 2560082 Office Cellphone: +91 - 9149068638	
Email: dct2_designs@gouravenergen.co.in	
Panel Title	415V AC LV Distribution Panel with 800A FP ACB

This drawing is conceived and designed at Gourav EnerGen India (P) Ltd. [GEIPL], Bareilly (UP) - INDIA. It is the property of GEIPL & therefore, it must not be copied, used or reproduced without the prior consent of the proprietor.

CIN - U31300UP1994PTC016434
Website: www.gouravenergen.co.in

S. No.	Symbol	Description	S. No.	Symbol	Description	S. No.	Symbol	Description	S. No.	Symbol	Description
1		Manually Operated Drawout type Air Circuit Breaker without Release	13		Electrically Operated Drawout type Air Circuit Breaker without Release	25		Manually Operated Drawout type Air Circuit Breaker with Release	37		Electrically Operated Drawout type Air Circuit Breaker with Release
2		Moulded Case Circuit Breaker with Release	14		Motor Protection Circuit Breaker	26		Switch Fuse Unit	38		Change Over Switch
3		Auxiliary Contactor	15		Power Contactor	27		Timer	39		Neutral Link
4		Indicating Light	16		Push Button	28		Illuminated Push Button	40		Capacitor Bank
5		Breaker Control Switch	17		Selector Switch	29		Core Balanced Current Transformer	41		Thermal Overload Relay
6		Push Button with 'NO' Element	18		Push Button with 'NC' Element	30		CT Shorting Link	42		kWh Meter with Comm. Port
7		Multi Function Meter	19		Multi Function Meter with Comm. Port	31		Electronic kWh Meter	43		Dual Source kWh Meter with Comm. Port
8		Ampere Meter	20		Volt Meter	32		Earthing	44		Cooling Fan
9		Under Voltage Relay	21		Over Voltage Relay	33		Reverse Power Relay	45		Master Trip Relay
10		AMF Relay	22		Alarm Annunciator	34		Control Transformer	46		Programmable Logic Controller
11		MCB	23		Control Fuse	35		APFC Relay	47		Power Factor Meter
12		Potential Transformer	24		Current Transformer	36		Bolt with washer	48		Pin Type Panel Lock

All Dimn. are in MM.			GEN	BOM	GAD	SYM	1/1	SLD	CCD	TBD	M/s GOURAV ENERGEN INDIA (P) LTD. (An ISO 9001:2015 & SANGAM Group Company)	
SCALE	NTS										Office : Administrative Block, Indl. Estate , Clutter Buck Gunj, Bareilly (U.P.) Landline: +91 - 581 -2561527, 2560082 Office Cellphone: +91 - 9149068638 Email: dct2_designs@gouravenergen.co.in	
DATE	04112025	15112025	CLIENT		M/s Tata Power Company Limited.		Address		Mumbai		Panel Title	415V AC LV Distribution Panel with 800A FP ACB
DRN	SS	SS	Project/ Site									
CHD	VBS	Dr#	TPCLMUM-1-251104E05									
APPR	VBS	Job #	20251104E-0001									

This drawing is conceived and designed at Gourav EnerGen India (P) Ltd. [GEIPL], Bareilly (UP) - INDIA. It is the property of GEIPL & therefore, it must not be copied, used or reproduced without the prior consent of the proprietor.

CIN - U31300UP1994PTC016434
 Website: www.gouravenergen.co.in

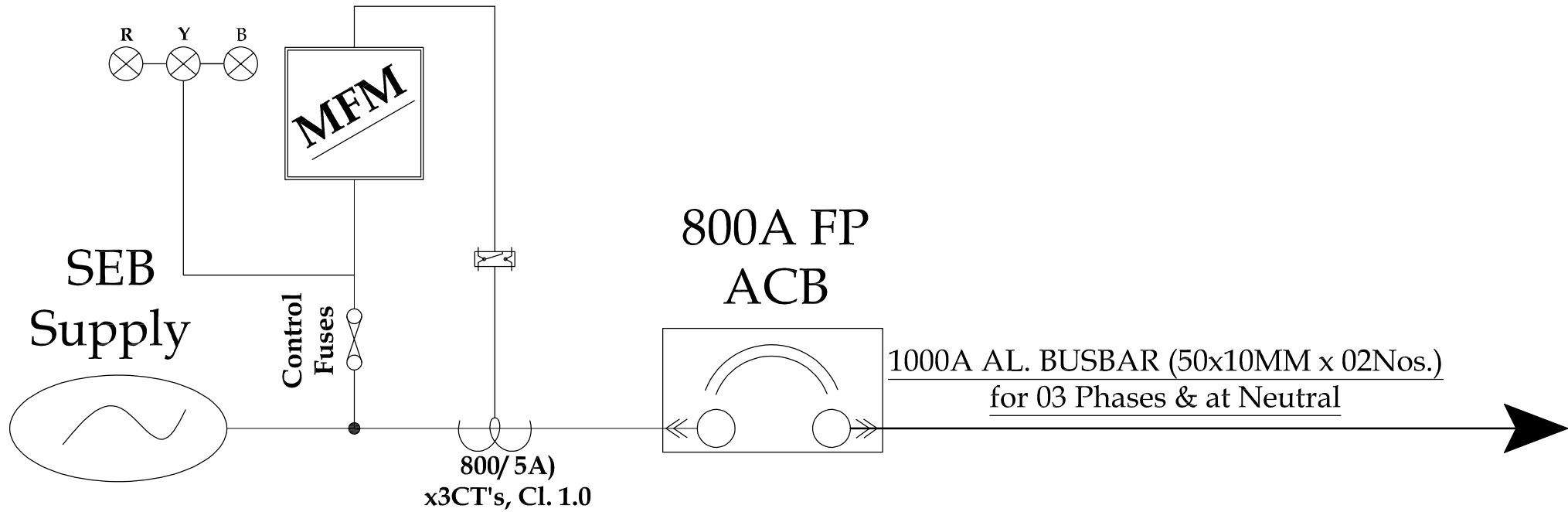

All Dimn. are in MM.			GEN	BOM	GAD	SYM	SLD	1/ 1	CCD	TBD
SCALE	NTS									
DATE	04112025	15112025								
DRN	SS	SS								
CHD	VS	Drg #	TPCLMUM-1-251104E06			CLIENT	M/s Tata Power Company Limited.			
APPR	VS	Job #	20251104E-0001			Address	Mumbai			
						Project/ Site				

M/s GOURAV ENERGEN INDIA (P) LTD. <i>(An ISO 9001:2015 & SANGAM Group Company)</i>	
Office : Administrative Block, Indl. Estate , Clutter Buck Gunj, Bareilly (U.P.) Landline: +91 - 581 -2561527, 2560082 Office Cellphone: +91 - 9149068638 Email: dct2_designs@gouravenergen.co.in	
Panel Title	415V AC LV Distribution Panel with 800A FP ACB



Gourav EnerGen India (P) Ltd.

{An ISO 9001:2015, ISO 14001:2015 and SANGAM Group Company}

www.gouravenergen.co.in



GENERAL TECHNICAL PARAMETERS 415V AC LV Distribution Panel with 800A FP MCCB

	GTPs for MCCB	800A MCCB	GEIPL Provided
	Vender Address and contact details		M/s Gourav Ener Gen India Pvt. Ltd. Administrative Block, Industrial Estate, C. B. Ganj Bareilly -243502 UP Mob. No.: 9359486426 Ph. No. 0581 - 2561527, 2561050
A	Ratings		
1	Ampere	800A MCCB	800A MCCB
2	Primary V	415V	415V
3	Phase	3 phases	3 phases
4	Frequency (Hz)	50Hz	50Hz
5	Ambient Temp C/Relative Humidity	50°C	50°C
6	Application	Outdoor	Outdoor
B	Enclosure		
1	Overall Limiting Dimensions W x D x H (mm)	To be provided by the bidder Minimum width 450 mm	550 (W) X 750 (D) X 1250 mm (H)
2	Gauge and material	16 Gauge M.S. Sheet	16 Gauge M.S. Sheet (1.6 mm)
3	Gland Plate Thickness		
4	Colour of Body	Powder Coated with Siemens Gray Shade No. 7032	Powder Coated with Siemens Gray Shade No. 7032
5	Protection grade of enclosure	IP 54	IP 54 with Fan & Filter
C	Bus Bar Size		
1	Phase Material Aluminium	2 X 50 X 10 mm	1000A Al. Bus Bar (50X 10 X 02 Nos.) / Eq. (In Size/ Area) for 3 Phases. (As per Switchgear Designs)
2	Neutral Material Aluminium	2 X 50 X 10 mm	1000A Al. Bus Bar (50X 10 X 02 Nos.) / Eq. (In Size/ Area) for 3 Phases. (As per Switchgear Designs)
3	Earth Material GI	1 X 50 X 6 mm	50 x 06 mm x 01 No. G.I. Earth Strip
4	Clearance B/ w Ph. to Ph.	20 mm	20 MM Min. as per Switchgear Designs
5	Clearance B/ w Ph. to N.	20 mm	20 MM Min.
D	MCCB		
1	Make	Schneider/ Siemens/ ABB	Schneider/ Siemens/ LK/ ABB
2	Rating(kA)	50kA	50kA
3	Pole/ Phase	FP	FP
4	Rating	800A MCCB	800A MCCB
5	Type	Manual Fixed	Manual Fixed
E	Indication		
1	Make	Schneider/ C&S/ Eq.	Reputed
2	RYB Phase Indicators with Control Fuses	Yes Provided	Yes Provided
F	Metering		
1	Make	Selec/ Eq.	Selec/ Secure/ LK/ Sch/ Eq.
2	Multifunction Meter without RS485 communication Port	Flush Mounting; Size - 96x96MM; Acc. Cl. 1.0; Parameters: V, A, F, etc.	Provided



Bills of Materials [BOM] - Switchgears, Controlgears, Instruments, etc.

S.#	ITEM DESCRIPTION							Qty	UOM
Component Name/ Description	MAKE	Item Rating/ Size	Ph./ Pole	kA, etc.	Type	Remarks			
Main Incomer - 1	SEB Supply	----	3Ph.	415V AC	----		1	Set	
1 MCCB with Thermal Magnetic Release having OL & SC Protections	Schneider/ Siemens/ LK/ ABB	800A	FP	Icu=50kA	Manual Fixed		1	Set	
2 MCCB Accessories - Spreader Links, Phase Barriers, Extended Rotary Handle etc.	Schneider/ Siemens/ LK/ ABB	800A	FP	----	----		1	Set	
3 Multifunction Meter without RS485 Port; Flush Mounting; Size - 96x96MM; Acc. Cl. 1.0; Parameters: V, A, Hz, PF	Selec/ Secure/ LK/ Sch./ Eq.	-/5A	3Ph-4W	230V AC	Digital LCD Display		1	Set	
4 Current Transformers for Metering; BPL Ring Type; CTR:: -/5A	EnerGen/ Eq.	800A	15VA	Cl. 1.0	Tape Wound		3	Nos.	
5 Polyamide CT Shorting Links - Disconnecting (Dropout) Type	Reputed	4.00Sq.MM	SP	----	Screw Clamp Type		3	Nos.	
6 RYB Phases Indication Lamps	Reputed	22.50MM	SP	230V AC	Integral LED Type		1	Set	
7 Control Fuse Base with HRC Fuse Link	C&S/ HPL/ Havells/ Eq.	2A	SP	230V AC	NS Type		3	Nos.	
8 Cooling Fan with Air Filter	Reputed	6"	SP	230V AC	ABS Body		1	Set	
9 Time Switch (220V AC) - for Cyclic operation of Cooling Fan	Selec/ Havells/ GIC/ Eq.	6A	SP	230V AC	Dial Type		1	No.	
10 Control Fuse Base with HRC Fuse Link	C&S/ HPL/ Havells/ Eq.	2A	SP	230V AC	NS Type		1	No.	

This drawing is conceived and designed at Gourav EnerGen India (P) Ltd. [GEIPL], Bareilly (UP) - INDIA. It is the property of GEIPL & therefore, it must not be copied, used or reproduced without the prior consent of the proprietor.

CIN - U31300UP1994PTC016434
Website: www.gouravenergen.co.in

All Dimn. are in MM.		GEN	BOM	1/ 1	GAD	SYM	SLD	CCD	TBD	M/s GOURAV ENERGEN INDIA (P) LTD. <i>(An ISO 9001:2015 & SANGAM Group Company)</i>	
SCALE	NTS									CLIENT M/s Tata Power Company Limited.	
DATE	04112025	5112025	Address Mumbai		Panel Title 415V AC LV Distribution Panel with 800A FP MCCB						
DRN	SS	SS	Project/P.O. TPCLMUM-1-251104B01								
CHD	VBS	Drg #	20251104B-0001								
APPR	VBS	Job #	20251104B-0001								

This drawing is conceived and designed at Gourav EnerGen India (P) Ltd. [GEIPL], Bareilly (UP) - INDIA. It is the property of GEIPL & therefore, it must not be copied, used or reproduced without the prior consent of the proprietor.

CIN - U31300UP1994PTC016434
 Website: www.gouravenergen.co.in

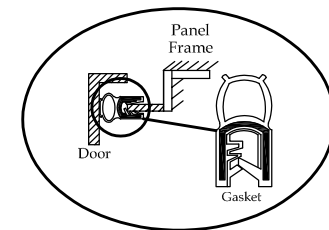
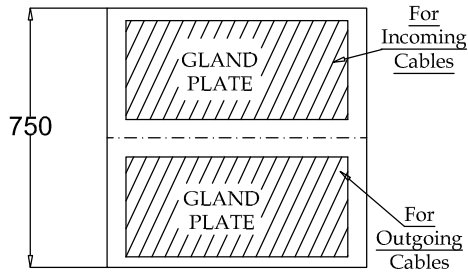
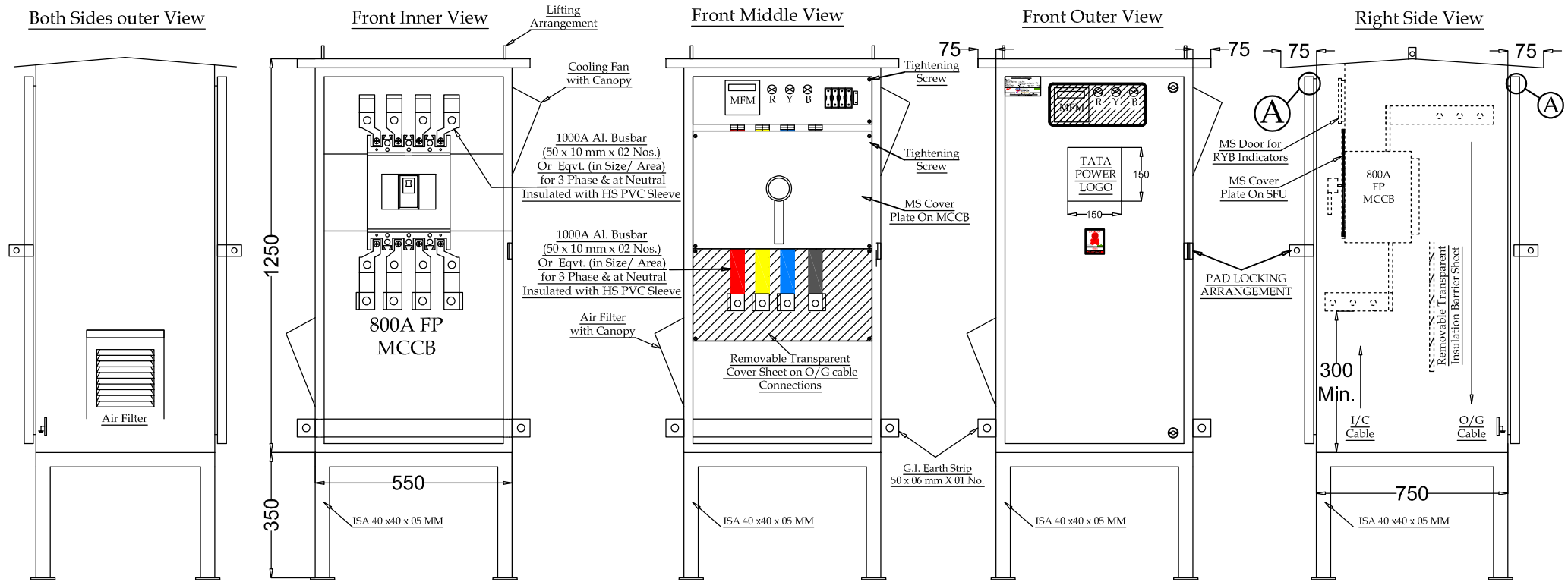

Detail's 'A'

Note:-

- 1-Min. Clearance Between Phase to Phase - 20 MM
- 2-Min. Clearance Between Phase to Neutral - 20 MM

All Dimn. are in MM.		GEN	BOM	GAD	1/2	SYM	SLD	CCD	TBD	M/s GOURAV ENERGEN INDIA (P) LTD. (An ISO 9001:2015 & SANGAM Group Company) Office : Administrative Block, Indl. Estate , Clutter Buck Gunj, Bareilly (U.P.) Landline: +91 - 581 -2561527, 2560082 Office Cellphone: +91 - 9149068638 Email: dct2_designs@gouravenergen.co.in
SCALE	NTS									
DATE	04112025/15112025	CLIENT	M/s Tata Power Company Limited.							
DRN	SS SS	Address	Mumbai							
CHD	VBS Drg #	TPCLMUM-1-251104B02	Project/P.O.							
APPR	VBS Job #	20251104B-0001								
Panel Title										415V AC LV Distribution Panel with 800A FP MCCB

This drawing is conceived and designed at Gourav EnerGen India (P) Ltd. [GEIPL], Bareilly (UP) - INDIA. It is the property of GEIPL & therefore, it must not be copied, used or reproduced without the prior consent of the proprietor.

CIN - U31300UP1994PTC016434
Website: www.gouravenergen.co.in

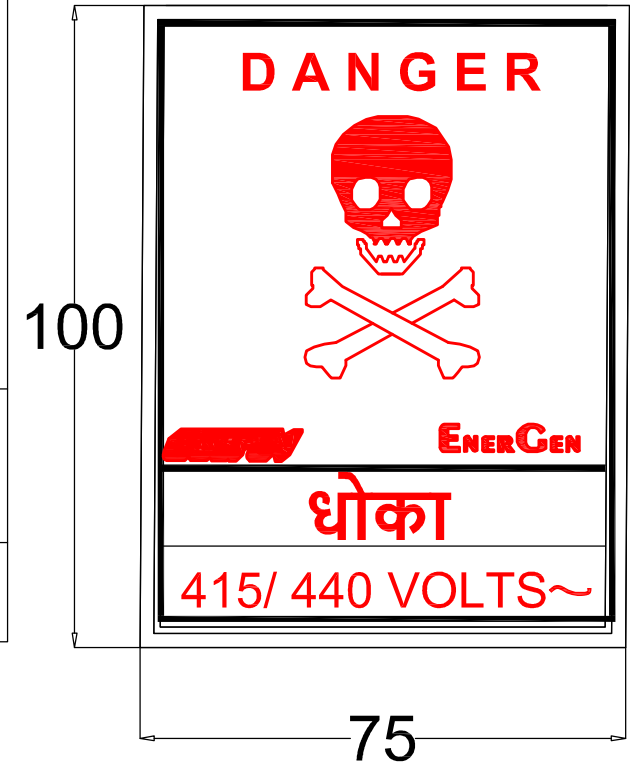
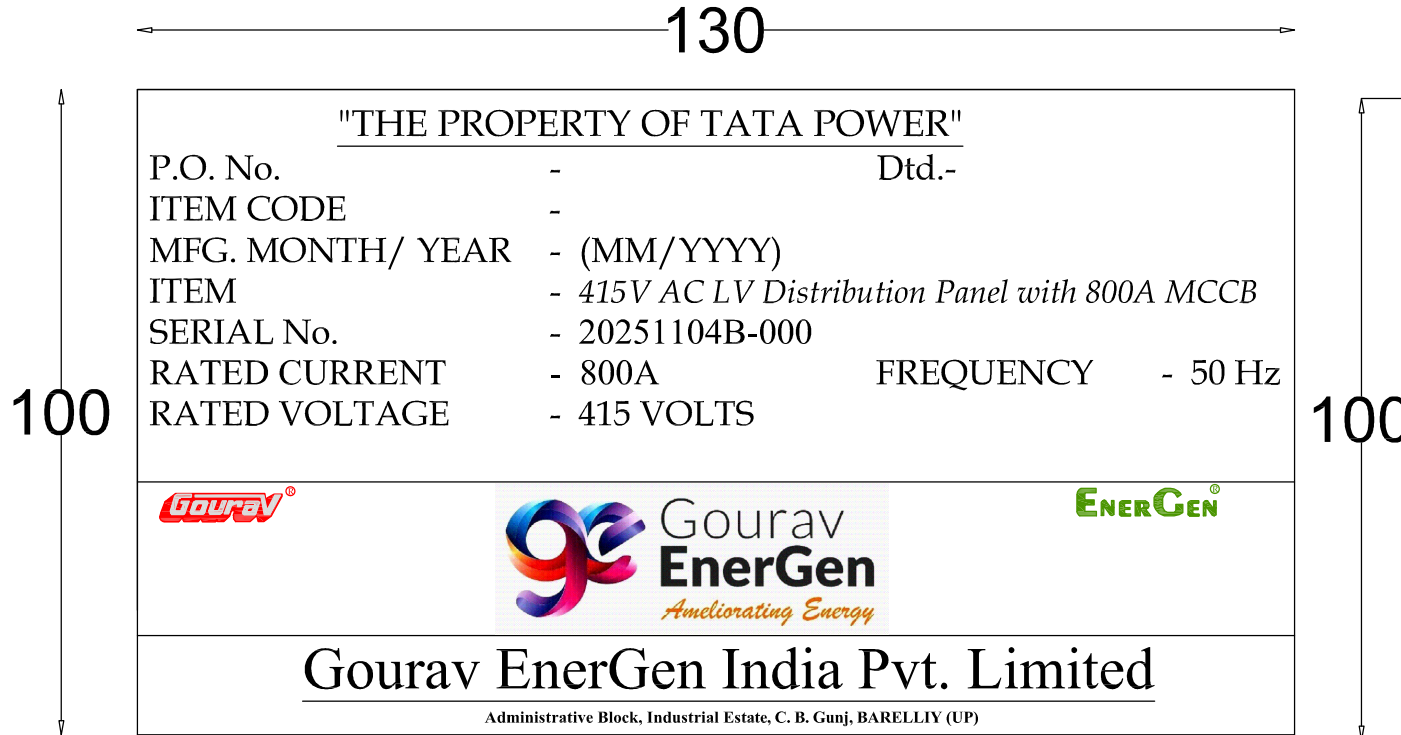

Colour Scheme For Panel Title Plate	
Font Colour	- White
Font Text Style	- Bold
Background Colour	- Black

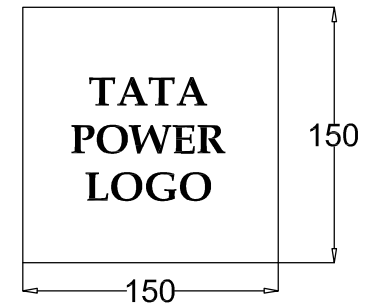

All Dimn. are in MM.		GEN	BOM	GAD	2/ 2	SYM	SLD	CCD	TBD	
SCALE	NTS									
DATE	04112025	5112025	CLIENT M/s Tata Power Company Limited.							
DRN	SS	SS	Address Mumbai							
CHD	VBS	Drg #	TPCLMUM-1-251104B03							
APPR	VBS	Job #	20251104B-0001							
Project/P.O.										

M/s GOURAV ENERGEN INDIA (P) LTD. <small>(An ISO 9001:2015 & SANGAM Group Company)</small>	
<small>Office : Administrative Block, Indl. Estate , Clutter Buck Gunj, Bareilly (U.P.) Landline: +91 - 581 -2561527, 2560082 Office Cellphone: +91 - 9149068638 Email: dct2_designs@gouravenergen.co.in</small>	
Panel Title	415V AC LV Distribution Panel with 800A FP MCCB

This drawing is conceived and designed at Gourav EnerGen India (P) Ltd. [GEIPL], Bareilly (UP) - INDIA. It is the property of GEIPL & therefore, it must not be copied, used or reproduced without the prior consent of the proprietor.

CIN - U31300UP1994PTC016434
Website: www.gouravenergen.co.in

S. No.	Symbol	Description	S. No.	Symbol	Description	S. No.	Symbol	Description	S. No.	Symbol	Description
1		Manually Operated Drawout type Air Circuit Breaker without Release	13		Electrically Operated Drawout type Air Circuit Breaker without Release	25		Manually Operated Drawout type Air Circuit Breaker with Release	37		Electrically Operated Drawout type Air Circuit Breaker with Release
2		Moulded Case Circuit Breaker with Release	14		Motor Protection Circuit Breaker	26		Switch Fuse Unit	38		Change Over Switch
3		Auxiliary Contactor	15		Power Contactor	27		Timer	39		Neutral Link
4		Indicating Light	16		Push Button	28		Illuminated Push Button	40		Capacitor Bank
5		Breaker Control Switch	17		Selector Switch	29		Core Balanced Current Transformer	41		Thermal Overload Relay
6		Push Button with 'NO' Element	18		Push Button with 'NC' Element	30		CT Shorting Link	42		kWh Meter with Comm. Port
7		Multi Function Meter	19		Multi Function Meter with Comm. Port	31		Electronic kWh Meter	43		Dual Source kWh Meter with Comm. Port
8		Ampere Meter	20		Volt Meter	32		Earthing	44		Cooling Fan
9		Under Voltage Relay	21		Over Voltage Relay	33		Reverse Power Relay	45		Master Trip Relay
10		AMF Relay	22		Alarm Annunciator	34		Control Transformer	46		Programmable Logic Controller
11		MCB	23		Control Fuse	35		APFC Relay	47		Power Factor Meter
12		Potential Transformer	24		Current Transformer	36		Bolt with washer	48		Pin Type Panel Lock

All Dimn. are in MM.			GEN	BOM	GAD	SYM	1/1	SLD	CCD	TBD	M/s GOURAV ENERGEN INDIA (P) LTD. (An ISO 9001:2015 & SANGAM Group Company) Office : Administrative Block, Indl. Estate , Clutter Buck Gunj, Bareilly (U.P.) Landline: +91 - 581 -2561527, 2560082 Office Cellphone: +91 - 9149068638 Email: dcl2_designs@gouravenergen.co.in	
SCALE	NTS											
DATE	04112025	15112025	CLIENT		M/s Tata Power Company Limited.							
DRN	SS	SS	Address		Mumbai							
CHD	VBS	Dr#	TPCLMUM-1-251104B04		Project/ Site						Panel Title	415V AC LV Distribution Panel with 800A FP MCCB
APPR	VBS	Job #	20251104B-0001									

This drawing is conceived and designed at Gourav EnerGen India (P) Ltd. [GEIPL], Bareilly (UP) - INDIA. It is the property of GEIPL & therefore, it must not be copied, used or reproduced without the prior consent of the proprietor.

CIN - U31300UP1994PTC016434
 Website: www.gouravenergen.co.in

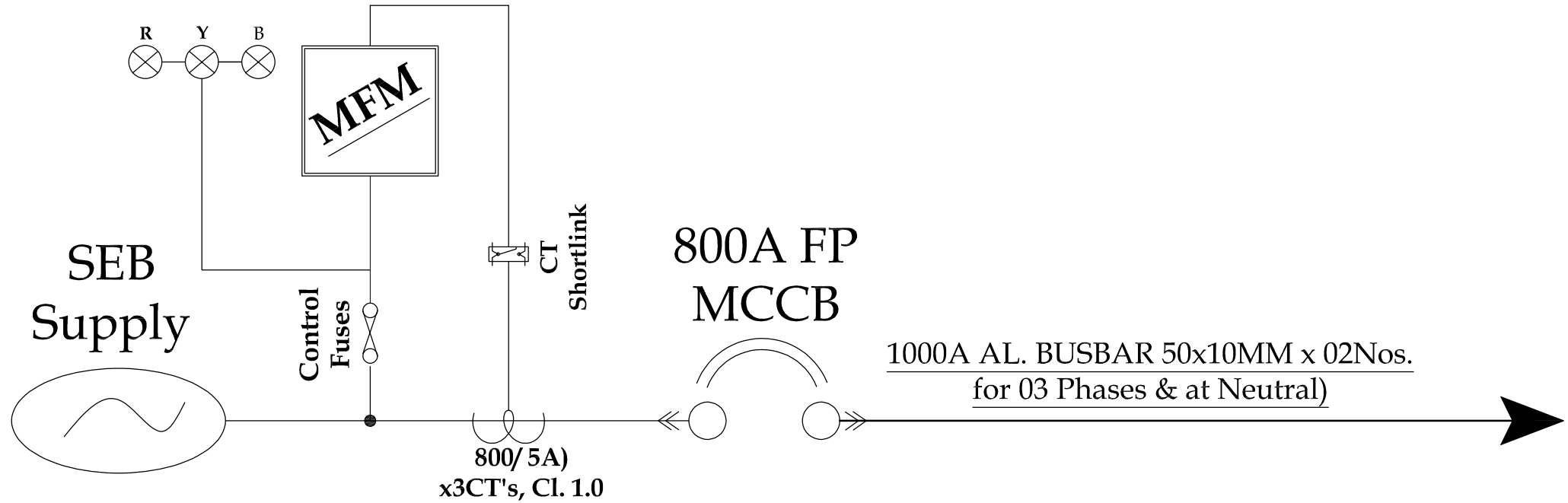

All Dimn. are in MM.			GEN	BOM	SYM	CCD	SLD	1/ 1	FDR	GAD
SCALE	NTS									
DATE	04112025	15112025	CLIENT		M/s Tata Power Company Limited.					
DRN	SS	SS	Address		Mumbai					
CHD	VS	Drg #	TPCLMUM-1-251104B05		Project/ Site					
APPR	VS	Job #	20251104B-0001							

M/s GOURAV ENERGEN INDIA (P) LTD. <i>(An ISO 9001:2015 & SANGAM Group Company)</i>	
Office : Administrative Block, Indl. Estate , Clutter Buck Gunj, Bareilly (U.P.)	
Tele-Fax: +91 - 581 - 2560082, 2561527 Phone: 3291383	
Email: geipl.design@gmail.com, gouravenergen@gmail.com	
Panel Title	415V AC LV Distribution Panel with 800A FP MCCB

5/14

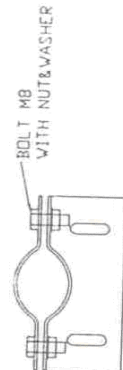
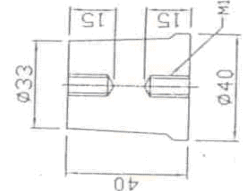
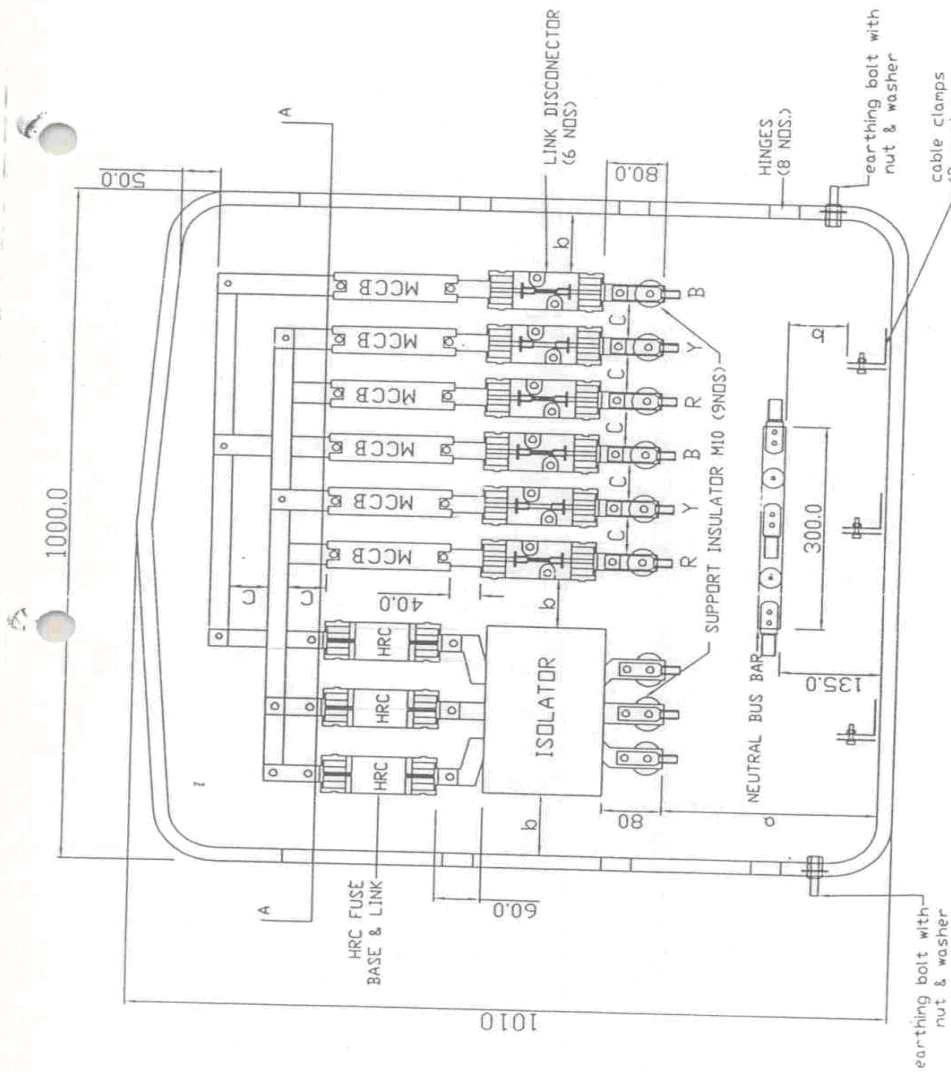

Front
SE (100)

ALL DIMENSIONS ARE IN MM
SCALE : N.T.S.

MSEDCL	DRG. NO. DIST./DB/05
DISTRIBUTION SECTION	L.T. DISTRIBUTION BOX WITH ASSY. DETAILS FOR 63/100 KVA (URBAN)
	5 (MM-IT) 5 (MM) 5 (MM-IT) 5 (MM)

THIS IS AN INDICATIVE DRAWING.



RFQ No.: 4100065975

ANNEXURE III
Schedule of Deviations

*Bidders are advised to refrain from taking any deviations on this TENDER. Still in case of any deviations, all such deviations from this tender document shall be set out by the Bidders, Clause by Clause in this schedule and submit the same as a part of the **Technical Bid**.*

*Unless **specifically** mentioned in this schedule, the tender shall be deemed to confirm the TPC's specifications:*

S. No.	Clause No.	Tender Clause Details	Details of deviation with justifications

By signing this document, we hereby withdraw all the deviations whatsoever taken anywhere in this bid document and comply to all the terms and conditions, technical specifications, scope of work etc. as mentioned in the standard document except those as mentioned above.

Seal of the Bidder:

Signature:

Name:

RFQ No.: 4100065975

ANNEXURE IV

Schedule of Commercial Specifications

(The bidders shall mandatorily fill in this schedule and enclose it with the offer Part I: Technical Bid. In the absence of all these details, the offer may not be acceptable.)

S.no	Particulars	Bidder's Response
1	Prices Firm or Subject to Variation (If variable indicate the price variation clause with the ceiling if applicable)	Firm / Variable
2	If Variable Price Variation on Clause given (if Yes indicate the Price Variation Ceiling in %)	Yes / No
3	Delivery Terms Acceptable	Yes / No
4	Guarantee Clause Acceptable	Yes / No
5	Terms of Payment Acceptable	Yes / No
6	Performance Bank Guarantee Acceptable	Yes / No
7	Liquidated Damages Clause Acceptable	Yes / No
8	Bid Validity Acceptable	Yes / No
9	Inspection during Stage of Manufacturing	Yes / No
10	Rebate for Increased Quantity	Yes / No
11	Change in Price for Reduced Quantity	Yes / No

RFQ No.: 4100065975

ANNEXURE V

Checklist of all the documents to be submitted with the Bid.

Bidder has to mandatorily fill in the checklist mentioned below: -

S. No.	Documents attached	Yes / No / Not Applicable
1	EMD of required value	
2	Tender Fee as mentioned in this RFQ	
3	Company profile/organ gram	
4	Signed copy of this RFQ as an unconditional acceptance	
5	Duly filled schedule of commercial specifications (Annexure IV)	
6	Sheet of commercial/technical deviation if any (Annexure III)	
7	Balance sheet for the last completed three financial years; mandatorily enclosing Profit & loss account statement	
8	Acknowledgement for Testing facilities if available (duly mentioned on bidder letter head)	
9	List of Machine/tools with updated calibration certificates if applicable	
10	Details of order copy (duly mentioned on bidder letter head)	
11	Order copies as a proof of quantity executed	
12	Details of Type Tests if applicable (duly mentioned on bidder letter head)	
13	All the relevant Type test certificates as per relevant IS/IEC (CPRI/ERDA/other certified agency) if applicable	
14	Project/supply Completion certificates	
15	Performance certificates	
16	Client Testimonial/Performance Certificates	
17	Credit rating/solvency certificate	
18	Undertaking regarding non blacklisting (On company letter head)	
19	List of trained/untrained Manpower	



RFQ No.: 4100065975

ANNEXURE VI

Acceptance Form for Participation in Reverse Auction Event

(To be signed and stamped by the bidder)

In a bid to make our entire procurement process fairer and more transparent, TPC intends to use the reverse auctions through SAP-SRM tool as an integral part of the entire tendering process. All the bidders who are found as technically qualified based on the tender requirements shall be eligible to participate in the reverse auction event.

The following terms and conditions are deemed as accepted by the bidder on participation in the bid event:

1. TPC shall provide the user id and password to the authorized representative of the bidder. *(Authorization Letter in lieu of the same shall be submitted along with the signed and stamped Acceptance Form).*
2. TPC will make every effort to make the bid process transparent. However, the award decision by TPC would be final and binding on the supplier.
3. The bidder agrees to non-disclosure of trade information regarding the purchase, identity of TPC, bid process, bid technology, bid documentation and bid details.
4. The bidder is advised to understand the auto bid process to safeguard themselves against any possibility of non-participation in the auction event.
5. In case of bidding through Internet medium, bidders are further advised to ensure availability of the entire infrastructure as required at their end to participate in the auction event. Inability to bid due to telephone line glitch, internet response issues, software or hardware hangs, power failure or any other reason shall not be the responsibility of TPC.
6. In case of intranet medium, TPC shall provide the infrastructure to bidders. Further, TPC has sole discretion to extend or restart the auction event in case of any glitches in infrastructure observed which has restricted the bidders to submit the bids to ensure fair & transparent competitive bidding. In case of an auction event is restarted, the best bid as already available in the system shall become the start price for the new auction.
7. In case the bidder fails to participate in the auction event due any reason whatsoever, it shall be presumed that the bidder has no further discounts to offer and the initial bid as submitted by the bidder as a part of the tender shall be considered as the bidder's final no regret offer. Any offline price bids received from a bidder in lieu of non-participation in the auction event shall be outrightly rejected by TPC.
8. The bidder shall be prepared with competitive price quotes on the day of the bidding event.
9. The prices as quoted by the bidder during the auction event shall be inclusive of all the applicable taxes, duties and levies and shall be FOR at TPC site.
10. The prices submitted by a bidder during the auction event shall be binding on the bidder.
11. No requests for time extension of the auction event shall be considered by TPC.
12. The original price bids of the bidders shall be reduced on pro-rata basis against each line item based on the final all-inclusive prices offered during conclusion of the auction event for arriving at Contract amount.

Signature & Seal of the Bidder



RFQ No.: 4100065975

ANNEXURE VII
Inspection Test Plan

As per scope of work

CONFIDENTIAL



RFQ No.: 4100065975

Annexure VIII
General Conditions of Contract

Attached as Annexure to this document.

CONFIDENTIAL

The Tata Power Company Limited is hereunder referred to as the "Owner" or "Company". The person, firm or company offering the services, the subject of this order is referred to as "Contractor". The subject of this order is hereinafter referred to as the "Work".

"Sub-Contractor" means any person named in the Contract as a Sub-contractor, sub-vendor, manufacturer or supplier for a part of the Works or any person to whom a part of the Works has been subcontracted and the legal successors in title to such Person, but not any assignee of such Person.

The Contract shall mean the contract as derived from the following:

1. Work Order (with 'Commercial Notes' and Annexures to the Work Order referred thereon)
2. Scope of Work.
3. General Terms & Conditions - Service

The documents including all reference document (s) and Annexures forming the Contract are to be read together as a whole and are to be taken as mutually explanatory, provided however, in the event of any inconsistency or discrepancy between the aforementioned documents, the order of precedence in interpretation of the documents shall be as set out above. For the avoidance of doubt, it is clarified that the terms set forth in the Work Order (with 'Commercial Notes' and Annexures to the Work Order referred thereon) shall take precedence over the terms set out in the Scope of Work, which shall in turn take precedence of the terms set out in the General Terms & Conditions – Service.

1. Contractor's obligation:

- 1.1 Contractor warrants that it is a competent, qualified and experienced contractor, equipped, organised and financed to perform and complete the services in the operating area in an efficient and professional manner and capable of meeting all the requirements of the Contract.
- 1.2 The Contractor has the overall responsibility of executing the contract, conducting Planning, Job Scheduling, Maintenance Planning, Maintenance Job Scheduling, executing the Work and maintenance jobs as per the Scope of work & schedule.
- 1.3 Except to the extent that it may be legally or physically impossible or create a hazard to safety, the Contractor shall comply with the Owner's representative(s) instructions and directions on all matters relating to the Work.
- 1.4 Contractor shall at all times have full responsibility for control of the Equipment and for the direction and supervision of operations being carried out under the Contract.
- 1.5 In the performance of the Work, Contractor shall be and act as an independent Contractor fully responsible and accountable for the proper execution of its responsibilities, obligations and

liabilities under this Contract and for its own acts and the acts of its Sub-Contractors and the Personnel. Owner's supervision, examination or inspection of the (performance of the) Work or omission to carry out the same shall not be construed in any manner whatsoever as relieving Contractor from its responsibilities, obligations or liabilities under this Contract.

- 1.6 Contractor shall submit list of tools & tackles with details of make, year of manufacturing, valid certification to the Project Manager/ User for their approval.

Project Manager may during the execution of project inspect & verify that the tools & tackles are as per the qualification requirements approved by him and will have right to seek replacements in case of any discrepancies. The Contractor shall always comply with such directives.

- 1.7 Contractor shall engage Tata Power Skill Development Institute (TPSDI) certified labour force at the site for execution of the job. Requirement & fees for TPSDI certification shall be as per Company Policy.
- 1.8 Contractor shall take full responsibility for the protection and security of Owner's materials and equipment while such materials and equipment are temporarily stored in Contractor's facility or otherwise in Contractor's custody.
- 1.9 All notices, instructions, information, and other communications given by the Contractor to Owner under the Contract shall be given to the Order Manager/ Owner's representative, except as otherwise provided for in this Contract.
- 1.10 The Contractor shall make its own arrangements for movement of personnel and equipment, within and outside the sites / units / offices at the various locations covered by the Contract.
- 1.11 The Contractor shall acquire in its name all permits, approvals, and/or licenses from all local, state, or national government and other statutory authorities and/or public service undertakings that are necessary for the performance of the Contract.
- 1.12 Neither the Contractor nor its personnel shall during the term of this Contract, engage in any business or professional activities in India/abroad which would conflict with the activities assigned to them under this Contract.

2. Service Warranties:

Contractor warrants that all services performed for or on behalf of Owner will be performed in a competent,

workmanlike manner and shall be free from faults and defects. Said warranties shall be in addition to any warranties of additional scope given by Contractor to Owner. None of said warranties and no other implied or express warranties shall be deemed is claimed or excluded unless evidenced by a change notice or revision issued and signed by Owner's authorized representative.

3. Compliance of Local Laws:

Contractor shall be responsible and shall comply with the provision of all the Statutory Acts Applicable. Special attention of the Contractor is drawn towards the compliance of provision of the following statues: (along with the latest amendments/additions, as applicable):

- a) The Child Labour (Prohibition and Regulation) ACT, 1986.
- b) The Contract Labour (Regulation and Abolition) ACT, 1970.
- c) The Employee's Pension Scheme, 1995.
- d) The Employee's Provident Funds and miscellaneous provisions Act, 1952.
- e) The Employees State Insurance Act, 1948.
- f) The Equal Remuneration Act, 1976.
- g) The Industrial Disputes Act, 1947.
- h) The Maternity Benefit Act, 1961.
- i) The Minimum Wages Act, 1948.
- j) The Payment of Bonus Act, 1965
- k) The Payment of Gratuity Act, 1972.
- l) The Payment of Wages Act, 1936.
- m) The Shops & Establishment Act, 1954.
- n) The Workmen's Compensation Act, 1923.
- o) The Employer's Liability Act, 1938.
- p) and any other applicable statutory act

Site Specific requirements shall be as Annexure at I. The compliance to these Site Specific requirements shall not absolve the Contractor of its obligation to comply with the Owner's Contractor Safety Management Policy.

4. Owner's Obligation:

- 4.1 The order manager (As specified in the 'Commercial Notes') shall have the authority to represent Owner on all day-to-day matters relating to the Contract or arising from the Contract. All notices, instructions, orders, certificates, approvals, and all other communications under the Contract shall be given by the order manager, except as otherwise provided for in this Contract. The order manager may appoint the Engineer-In-Charges for different areas for monitoring the work progress, inspections and signing of bills.

- 4.2 Owner shall ensure the availability of site access, all information and/or data to be arranged/ supplied by Owner to the Contractor for execution of the Work . The terms on which the Contractor shall be allowed access to the site shall be specified by the Owner prior to commencement of the execution of the Work and thereafter shall be governed in accordance with such policies as the Owner may provide in writing to the Contractor from time to time.

5. Contractor's/ Sub-contractor's employees:

- 5.1 The Contractor shall engage appropriately qualified persons to provide the services with the prior approval of Owner. Owner may withhold such approval for any reason whatsoever.

- 5.2 The Contractor hereby represents and warrants that:

- i) the personnel are duly qualified, and are, and will remain, sufficiently qualified, careful, skilful, diligent and efficient to provide the services to Owner; and
- ii) the Services will be rendered carefully, skilfully, diligently and efficiently, and to the professional standard reasonably expected by Owner of a contractor qualified and experienced in providing services substantially the same as the Services.

- 5.3 The Contractor must ensure that the Contractor's personnel conduct themselves in a proper manner and comply with the procedures and all policies, regulations and directives of Owner including any occupational, health and safety policies and the relevant prevailing laws and regulations in the Country of operations and specifically in the area where Work is being executed.

- 5.4 Owner may inform the Contractor to immediately remove Contractor's personnel from the relevant premises in the event of misconduct or incompetence on the part of the Personnel. The Contractor shall at all times remain liable for all acts and/or omissions of its Personnel.

- 5.5 It is made clear that no relationship of Owner and employee is created between Owner and the Contractor's resident engineers, employees and no claim for employment of any such personnel shall be tenable or entertained.

6. Title of Property:

- 6.1 Unless otherwise provided in this order or agreed to in writing, property of every description including but not limited to all tooling, tools, equipment and material furnished or made available to Contractor, title to which is

in Owner, and any replacement thereof shall be and remain the property of Owner. Such property other than material shall not be modified without the written consent of Owner. Such property shall be plainly marked or otherwise adequately identified by Contractor as being owned by Owner and shall be safely stored separately and apart from Contractor's property.

6.2 Contractor shall not use such property except for performance of work hereunder or as authorized in writing by Owner. Such property while in Contractor's possession or control shall be listed in writing and kept in good condition, shall be held at Contractor's risk, and shall be kept insured by Contractor, at its expense, in an amount equal to the replacement cost with loss payable to Owner. To the extent such property is not material consumed in the performance of this order, it shall be subject to inspection and removal by Owner and Owner shall have the right of entry for such purposes without any additional liability whatsoever to Contractor. As and when directed by Owner, Contractor shall disclose the location of such property, prepare it for shipment and ship it to Owner in as good condition as originally received by Contractor, reasonable wear and tear excepted.

7. Work Completion schedule:

Contractor shall plan and execute the Work in accordance with a detailed schedule mutually agreed upon by the Parties (Owner and Contractor).

8. Contract Price and Payment:

8.1 The Contract Price shall be a firm & fixed Contract Value for the Work inclusive of all the taxes, levies & duties and shall remain firm till the validity of this contract.

8.2 Unless Specifically stated elsewhere in the contract, the Contractor is solely liable for payment of , and warrants that it will pay, or ensure the payment of all taxes imposed, assessment made in relation to the Work.

8.3 An amount as stated in the table below shall be retained towards Contractor's safety performance against every RA bill:

Contract Value	Retention Amount (%)
Upto Rs. 10 lakhs	2.5
Above Rs. 10 lakhs and below Rs. 50 lakhs	2
Above 50 lakhs and upto Rs. 10 Crores	1.5
Above Rs. 10 Crores	1

Rev. date: 25 Jul 2017

The above mentioned safety retention shall be over and above any other retentions/ deferred payments as may have been specifically agreed in the Contract.

8.4 For Contract Price Rs. 1 crores or above and Contract Completion Schedule 12 months or more, the above safety retention will be released half yearly against the Safety Performance Score (methodology for evaluation enumerated in the Safety Terms & Conditions attached as Appendix to this General Terms & Condition) which will be evaluated by the Order Manager every month. For all other contracts, the above said safety retention shall be released along with the final settlement only at the end of the contract period.

8.5 The Owner shall have the right to stop any work which in its opinion is not meeting the safety standards/ guidelines of the Owner and good engineering practice. The Contractor shall not be eligible for and shall not be granted any extension in Completion Schedule due to such stoppage of work by the Owner.

8.6 The above retention towards safety shall not absolve the Contractor of its liabilities including statutory liabilities towards safety violations, injury or death (whether by accident or otherwise). An amount between Rs. 5 to 50 lakhs as deemed appropriate by Owner's appointed Committee for incident investigation and/ or as determined by statutory authorities (whichever higher), will be payable by the Contractor in case of such severe incidents of injury leading to loss of property or partial/ permanent disablement (e.g. loss of limb/s, vision etc.) or death.

8.7 Notwithstanding anything else stated in the Contract, the Contractor shall be liable for termination without any notice and without recourse to Owner in case of three (3) or more severe safety violations. There shall be no termination fees/ compensation payable to Contractor for such termination.

8.8 In case the Contractor achieves 100% on the Safety Performance Score, the Contractor shall be awarded a discretionary bonus of 1% of invoiced value subject to a maximum of Rs. 50 lakhs towards Safety Performance.

8.9 Payment shall be released within 60 days of submission of error free invoice with supporting documents duly certified by the Order Manager/ Engineer-in-Charge after deducting taxes at source as prescribed under the applicable law, income – tax or other deductions under the state value added tax laws . If such payment release

day falls on a holiday of Owner, payment will be released on the next working day. Against deduction of statutory taxes, tax deduction certificates where ever applicable shall be issued as per the applicable provisions of the statute. The Order Manager may recover any amount wrongly paid in excess in any previous bills certified by him.

8.10 *Mode of Payment:* All payments shall be made direct to the Contractor or his authorized representative in the shape of RTGS or Electronics Transfer method, on certification of the Order Manager/Engineer-in-Charge and on compliance of contractual terms & conditions.

9. **Taxes and Duties:**

9.1 The Contract Price shall be inclusive of all taxes, duties, including but not limited to Customs duty, GST or any local taxes, levies imposed by State/Central/Local governments.

9.2 Taxes as mentioned in the Contract Price or Price Schedule shall be paid to the contractor subject to the Contractor complying with all the statutory requirements and furnishing the relevant documents including error free invoices containing detailed break up of the taxes.

9.3 The tax invoices should contain the details to comply with the GST Law. The supplier shall:

- i) Furnish (electronically) and communicate to the Owner, the details of Goods or Services supplied by the 10th of the month succeeding the said tax period,
- ii) Upon discovery of any discrepancy, rectify it and shall pay the tax and interest thereof,
- iii) Furnish the returns (electronically), for the inward and outward supplies of Goods and/or Services, before the specified dates as per the GST Law,
- iv) Communicate the tax paid, credits etc. as and when credited.
- v) The Invoice should clearly state the description of the goods, quantity, sale price, tax %, and tax amount;
- vi) The Invoice should be signed by an Authorized Signatory.

Bills/Invoices in the name of The Tata Power Company Ltd. with packing lists in triplicate shall be forwarded along with the equipment.

Contractor to furnish GST Registration no. in all invoices as well as Purchaser's (Tata Power's) GST no.

9.4 However the payment of tax shall be restricted to the total amount as indicated in the price schedule.

9.5 Any statutory variation in duties, levies or taxes if applicable and specified in this Contract till the scheduled date for completion of Work and limited to direct invoices of the Contractor shall be to the account of Owner. The Contractor shall have the obligation to provide the necessary documentary evidence / supporting by way of gazetted notifications etc. to prove the change in such levies or taxes between the due date of submission of the Bid and the scheduled date of completion of work to claim the difference.

9.6 The Contractor shall pass on to the Owner all the benefits of either reduction in tax rates, exemptions, concessions, rebate, set off, credits etc. or introduction of new tax rates exemptions, concessions, rebate, set off, credits etc. pertaining to all taxes, duties, imposts, fees and levies in respect of the supplies of Goods or performance of obligations under the contract. This would specifically include reduction of tax rates as a result of statutory changes or judicial rulings.

9.7 Any other taxes, levies and duties not mentioned in Contract Price or Price Schedule but applicable as per any statute (s) or introduction (omission) of new taxes, levies and duties shall be deemed to be included in the Contract Price and shall be to the account of the Contractor.

9.8 For facilitating availment of a credit, set-off, rebate, drawback or like benefit available to the Owner, the Contractor will facilitate the Owner by providing the necessary documentary and/or procedural support. In any process of assessment or re-assessment, of taxes payable by the Owner,

9.9 The Contractor shall bear and pay all the costs, liabilities, levies, interest, penalties in respect of non-compliances of any legal requirements as per various statutory provisions. The contractor shall keep the owner indemnified at all times from any tax liability, interest, penalties or assessments that may be imposed by the statutory authorities for non-compliances or non-observation of any statutory requirements by the Contractor.

9.10 All formalities required under statutes, for availing any concessions under relevant tax laws shall be adhered to by the Contractor.

9.11 Deduction at source: Recovery at source towards income tax calculated at the rate prescribed from time to time under the Income Tax Act 1961 and other relevant sections of Income Tax Act shall be made from the bills of the Contractor and the amount so recovered shall be

deposited with the Income Tax Department. Necessary TDS certificate to this effect will be issued to the Contractor in the prescribed proforma.

- 9.12 If any other taxes / duties / cess etc are to be recovered at source as per government regulations / Legislation from time to time, the same shall be recovered from the bills payable to the Contractor. Necessary receipt to this effect will be issued to the Contractor in this regard as per the applicable legislation.

10. Contract Performance Guarantees (If applicable)

The Contractor shall within 15 days of issuance of this Order/Contract furnish an unconditional irrevocable bank guarantee duly stamped, strictly as per the prescribed format of Owner from any nationalized bank or any scheduled bank having a branch in Mumbai and approved by the Owner for a sum equivalent to 10% of the Total Contract Price valid for the Contract Period and with a claim period of not less than 6 months from the completion of Contract Period. The issuing bank should be advised to send a direct confirmation of issue of bank guarantee to Owner.

In case the Contractor fails to furnish the requisite Bank Guarantee as stipulated above, then the Owner shall have the option to cancel the Contract besides other contractual remedies.

11. Price Reduction:

- 11.1 In case the Contractor fails to deliver the service/ Complete the work as per the agreed Completion Schedule including intermediate milestones (if applicable), the Owner shall recover from Contractor, as ascertained and agreed Liquidated Damages, and not by way of penalty, a sum equivalent to 1% of the Contract Value per week of delay. The Liquidated Damages referred above may be recovered by the Owner as set off against any amounts payable by the Owner to the Contractor or in any other manner in accordance with applicable laws.
- 11.2 The overall cap on liquidated damages shall be limited to 10% of the Contract Price.

12. Insurance

- 12.1 The Contractor agrees to indemnify and protect Owner against all liability, claims or demands for injuries or damages to any person or property growing out of the performance of this order/ Contract.
- 12.2 The Contractor further agrees to furnish evidence of insurance showing that Contractor has and will maintain adequate insurance coverage during the life of this Contract/ order in the opinion of Owner, including but not

limited to comprehensive general liability insurance. Such evidence of insurance must set forth the name of the insurer, policy number, expiration date, and limits of liability. Compliance by Contractor with insurance requirements does not in any way affect Contractor's indemnification of Owner under Indemnification clause

13. Indemnification:

The Contractor shall indemnify, save harmless and defend the Owner and keep the Owner indemnified from and against any and all claims, costs, liabilities (financial), litigations, compensations, judgments, expenses or damages (including attorney's fees and other related expenses) arising out of any breach or alleged breach of any of the conditions of this Contract including compliance to statutory laws of provisioned under clause 3, performance of the obligations hereunder, or any representation or misrepresentation made by the Contractor or by any third party in respect of death or bodily injury or in respect to loss or damage to any property with regard to the subject of this Contract.

14. Indemnity against IPR:

The equipment, system, drawings, and other materials that shall be supplied against the Contract will become the Owner's property. Without limitation of any liability of whatsoever nature, the Owner shall be indemnified and kept indemnified against any claim for infringement or breach of any of the statues, rules & regulations by the use of or sale of any article or material supplied by the Contractor. The indemnity shall include any infringement of patent, trade mark, design, copyright or other property rights whether in Country of Origin, or elsewhere resulting from the Contractor's design, manufacture, use, supply or re-supply & would also cover use or sale of any article or material supplied by the Contractor to the Owner under the Contract. The Indemnity shall cover any claim/action taken by a third party either directly against the Owner or any claim/action made against the Contractor & where under the Purchaser is made liable. The Indemnity shall be for losses, damages, and costs including litigation costs, attorney fees etc incurred by the Owner in relation to the Contract.

15. Free Issue Material:

Wherever contracts envisage supply of Free Issue Material (FIM) by the Owner to the contractor for fabrication/ use in service performance, such Free Issue Material shall be safeguarded by an insurance policy to be provided by the Contractor at his own cost for the full value of such materials and the insurance policy shall cover the following risks specifically and shall be valid for six months beyond the Contract Validity date :

RISKS TO BE COVERED: Any loss or damage to the Owner's materials due to fire, theft, riot, burglary,

strike, civil commotion, terrorist act, natural calamities etc. and any loss or damage arising out of any other causes such as other materials falling on Owner's materials.

The amount for which insurance policy is to be furnished shall be indicated in the respective Contract.

Free Issue material (FIM) will be issued to the Contractor only after receipt of the Insurance Policy from the Contractor. The contractor shall arrange collection of the FIM from the Owner's premises and safe transportation of the same to his premises at his risk and cost. Notwithstanding the insurance cover taken out by the Contractor as above, the Contractor shall indemnify the Owner and keep the Owner indemnified to the extent of the value of free issue materials to be issued till such time the entire contract is executed and proper account for the free issue materials is rendered and the left over/surplus and scrap items are returned to the Owner. The contractor shall not utilize the Owner's free issue materials for any job other than the one contracted out in this case and also not indulge in any act, commission or negligence which will cause/result in any loss/damage to the Owner and in which case, the Contractor shall be liable to the Owner to pay compensation to the full extent of damage/loss. The Contractor, shall be responsible for the safety of the free issue materials after these are received by them and all through the period during which the materials remain in their possession/control/custody. The Free issue materials on receipt at the Contractor's works shall be inspected by them for ensuring safe and correct receipt of the material. The contractor shall report the discrepancies, if any, to the Owner within 5 days from the date of receipt of the material. The contractor shall take all necessary precautions against any loss, deterioration, damage or destruction of the FIMs from whatever cause arising while the said materials remain in their possession/custody or control. The free issue materials shall be inspected periodically at regular intervals by the Contractor for ensuring safe preservation and storage, the Contractor, shall also not mix up the materials in question with any other goods and shall render true and proper account of the materials actually used and return balance remaining unused material on hand and scrap along with the final product and if it is not possible within a period of one month from the date of delivery of the final product/ completion of Service covered by this Contract. The Contractor shall also indemnify the Owner to compensate the difference in cost between the actual cost of the free issue material lost/damaged and the claim settled to the Owner by the insurance company.

16. Relation between parties:

The Contract shall be entered into on a principal-to-principal basis only. The Contract shall not be construed as a partnership or an association of persons. There is no agent and principal relationship between the parties. Each party shall be responsible for its own conduct. The Contractor shall ensure at all times that all the work carried out under this contract

either by its own person or through any of its sub-Vendors shall be always done under its own direct supervision.

17. Safety:

Contractor shall comply with all legal and statutory provisions including all rules and regulations pertaining to Safety, Health and the Environment and will be responsible for all legal liabilities arising due to any of their acts or of their personnel.

The Contractor shall comply with the Owner's Contractor Safety Policy and Safety Terms and Conditions. Any misconduct and/ or violation with respect to the Owner's Contractor Safety Policy and Safety Terms and Conditions or any other legal and statutory provisions pertaining to Safety, Health and Environment shall be dealt with as per the Safety Terms and Conditions.

Prior to commencement of any work at site Contractor shall submit an undertaking in writing to adhere to and comply with all the provisions of Owner's Contractor Safety Code of Conduct.

The Contractor shall have a valid ISO 14001/ OHSAS certification. In absence of the same, the Contractor shall obtain the same within 6 months from the date of the Effective Date of Contract.

18. Suspension of Work

Owner may instruct Contractor at any time to suspend performance of the Work or any part thereof with a notice of 7 days for whatever reason. Provided Contractor is not in default under this Contract subject to Articles 1 and 5 inclusive, the Contractor shall be paid a mutually agreed fee, if any, necessarily incurred by Contractor as a direct consequence thereof of suspension and the Project Completion Schedule may be revised accordingly.

Without prejudice to any other rights Owner may have under this Contract or at law if Contractor is in default under this Contract, Owner may instruct Contractor to suspend performance of the Work or any part thereof by giving 7 days notice till such default has been corrected to the satisfaction of Owner. Also Liquidated Damages in accordance with Clause 11 shall continue to be applicable during such period until the default is cured. The costs incurred by the Contractor for such correction shall be to the Contractor's account, and furthermore no payment shall become due to the Contractor. Any cost incurred due to non - performance of the Contractor by the Owner shall be charged to the Contractor.

19. Change Management:

Owner shall have the right at any time to order any change in the Work in accordance with the following procedure. Contractor shall furnish to Owner upon request as soon as reasonably possible but no later

than five (5) days following the request, a written statement specifying:

- (a) the increase or decrease, as the case may be, in the costs of the Work which will result from a change in the Work as requested by Owner,
- (b) any effect such change in the Work may have on any other provision of this Contract originating from either parties, and
- (c) such other details as Owner may require.

Any change in costs shall be reasonably related to the proportional change in the Work and any other costs incurred by Contractor. If Owner agrees to Contractor's statement Owner shall notify Contractor thereof in writing in the form of a change order, whereupon the change in the Work shall be incorporated in the Work and immediately implemented. In the event that the change relates to a reduction in Work, the work in question shall not be undertaken pending the issue of an appropriate Change Order.

20. Governing Laws

This Contract shall be construed in accordance with and governed by the Laws of India without giving effect to any principle of conflict of law.

21. Jurisdiction

This Contract and the transaction contemplated herein shall be subject to the exclusive jurisdiction of the competent Courts in Mumbai only.

22. Dispute settlement:

Dispute or differences arising out or relating to this Order shall be resolved amicably by the parties. Failing such amicable resolution of dispute / differences either party may refer the matter to arbitration of a Sole Arbitrator to be appointed jointly by both the parties. The award of the Arbitrator shall be final, binding and conclusive on the parties. The venue for arbitration shall be Mumbai. The Arbitration proceedings will be governed and regulated by the provisions of Indian Arbitration and Conciliation Act, 1996 as amended from time to time and the rules framed there under.

23. Force majeure:

- 23.1 In the event of either party being rendered unable by force majeure to perform any obligation required to be performed by it under this Contract the relative obligation of the party affected by such force majeure shall, after notice under this articles be suspended for the period during which such cause lasts. The term 'Force Majeure' as employed herein shall mean acts of God, wars (declared or undeclared), riots or civil commotion, fire, floods, and acts and regulations of the Government of India or State Government or any of the statutory agencies. Both the party

shall pay to the other party, the amount payable upon the date of the occurrence of such force majeure.

- 23.2 Upon the occurrence of such cause and upon its termination, the party alleging that it has been rendered unable as aforesaid, thereby shall notify the other party in writing immediately but not later than twenty four (24) hours of the alleged beginning and ending thereof giving full particulars and satisfactory evidence in support of the claims.

- 23.3 During the period, the obligations of the parties are suspended by force majeure; the contractor shall not be entitled to payment of any rate.

- 23.4 In the event of the force majeure conditions continuing or reasonably expected to continue for a period more than thirty (30) days, Owner shall have the option of terminating the contract by giving seven (7) days notice thereof to the contractor.

24. Sub letting and Assignment

The contractor shall not, without prior consent in writing of the Owner, sublet, transfer or assign the contract or any part thereof or interest therein or benefit or advantage thereof in any manner whatsoever, provided nevertheless that any such consent shall not relieve the contractor from any obligation, duty or responsibility under the contract.

25. Limitation of Liability:

Notwithstanding anything contained in the Contract, the Contractor's aggregate liability under this Contract shall be limited 100% of the Total Contract value. This shall exclude liability arising pursuant to clause 3- Compliance to Local Laws, clause 9.10, clause 14- Indemnity against IPR, clause 13- Indemnity, clause 26 – Confidentiality, liability arising due to loss of or damage to the Free Issue Material (FIM) issued by Owner to Contractor for completion of the Work and liability arising due to wilful misconduct, gross negligence, third party claims and corrupt acts attributable to the Contractor.

26. Confidentiality:

The Contractor shall use the Confidential Information of the Owner only in furtherance of this Contract and shall not transfer or otherwise disclose the Confidential Information to any third party. The Contractor shall (i) give access to such Confidential Information solely to those employees with a need to have access thereto; and (ii) take the same security precautions to protect against disclosure or unauthorized use of such Confidential Information that the party takes with its own confidential information but, in no event, shall a party apply less than a reasonable standard of care to prevent such disclosure or unauthorized use.

27. Termination:

27.1 The Contract shall be deemed to be terminated on completion of the Contract period.

27.2 Termination of default by Contractor:
Owner may terminate the contract at any time if the Contractor fails to carry out any of his obligations under this Contract. Prior to termination, the Contractor shall be advised in writing of the causes of unsatisfactory performance to be improved upon 15 days of the receipt of notice. In case, if the Contractor fails to bring about the improvement to the satisfaction of the Owner, then the Contract shall be terminated.

27.3 Without prejudice to the rights and remedies available to Owner, Owner may terminate the Contract or part thereof with immediate effect with written notice to the Contractor if:

27.3.1 The Contractor becomes bankrupt or goes into liquidation.

27.3.2 The Contractor makes a general assignment for the benefit of creditors.

27.3.3 A receiver is appointed for any substantial property owned by the Contractor.

27.3.4 The Contractor is in breach of any representation or warranty made to the Owner by the Contractor.

The Contractor shall not be entitled to any further payment under the Contract if the Contract is terminated. If the order is terminated under clause 27.2 and 27.3, the Contractor shall not be entitled to any further payment, except that, if Owner completes the Work and the costs of completion are less than the Contract Price, the Owner shall pay Contractor an amount properly allocable to services fully performed by Contractor prior to termination for which payment was not made to Contractor. In case, the cost of completion of Work exceeds the Contract Price, the additional cost incurred by Owner for such completion shall be paid by the Contractor.

27.4 Owner shall be entitled to terminate the Contract at its convenience, at any time by giving thirty (30) Days prior notice to the Contractor. Such notice of termination shall specify that termination is for Companies convenience and the date upon which such termination becomes effective. Upon receipt of such notice, the Contractor shall proceed as follows:

27.4.1 cease all further work, except for such work as may be necessary and instructed by the Owner/ Owner's representative for the purpose of preserving and protecting Work already in progress and protect

materials, facilities and equipment on the Work Site or in transit;

27.4.2 stop all further sub-contracting or purchasing activity, and terminate Sub-contracts;

27.4.3 handover all Documents, equipment, materials and spares relating to the portion of Work already executed by the Contractor or procured from other sources up to the date of termination for which the Contractor has received payment equivalent to the value thereof; and

27.4.4 handover those parts of the supplies manufactured/ work executed by the Contractor up to the date of termination.

Upon termination pursuant to clause 27.4, the Contractor shall be entitled to be paid (a) all sums properly due to the Contractor under the Contract up to the date of termination; and (b) any direct and substantiated charges already incurred or committed for cancellation of the procurement of third party goods or services which were to have been supplied by the Contractor in connection with this Contract provided that the Contractor shall use its best endeavours to minimise such charges

25.5 The Contractor shall not be released from any of his obligations or liabilities accrued under the Contract on termination. For the avoidance of doubt, the termination of the Contract in accordance with this clause shall neither relieve the Contractor of his accrued obligations for Warranty or his accrued liability to pay (liquidated) damages for Delay nor shall entitle him to reduce the value of Performance Security.

28. Consequential Damages:

Unless otherwise specified, neither Party shall be responsible for and nor shall be liable to the other Party for indirect/consequential losses and damages suffered by such Party including for loss of use, loss of profit whether such liability or claims are based upon any negligence on the part of the other Party or its employees in connection with the performance of the Contract.

29. Environment / ISO 14001 Certification:

The Contractor to confirm whether their organization is ISO 14001 certified. If not, the Contractor must certify that the handling, use and disposal of their product / by-products conform to practices consistent with sound environmental management and local statutes. The Contractor shall ensure that all the wastes are disposed in environmental friendly way with strict compliance to applicable laws including adherence to MoEF guidelines with respect to disposal of batteries, lead waste, copper cables, ash, waste oil, e-waste etc which shall be disposed through MoEF approved

parties only. The Contractor shall also be responsible to collect and recycle all the e-waste generated at the end of the product life cycle at its own costs and risks as per the MoEF guidelines/orders.

30. Non-Exclusive Agreement

This Contract is non-exclusive and Owner reserves the right to engage other contractors to perform similar or identical work. Contractor shall accord such other contractors adequate opportunity to carry out their contracts and shall accomplish the Work in co-operation with those contractors and with Owner, in accordance with such instructions as may be issued by the Owner from time to time.

31. Severability

In the event that any of the provisions, or portions or applications thereof, of this Contract are held to be unenforceable or invalid by any court or arbitration panel of competent jurisdiction, Contractor and Owner shall negotiate an equitable adjustment to the provisions of the Contract with a view towards effecting the purpose of the Contract and the validity and enforceability of the remaining provisions, or portions or applications thereof, shall not be affected thereby.

32. Housekeeping & Removal of scrap:

The Contractor shall be responsible for keeping the areas of his work at site, neat and tidy throughout the period of his work. All excess material/ spares/ consumables taken by Contractor, as well as the scrapped items and wooden logs/ crates/ planks shall be returned, from time to time, to the Stores, and transported/ unloaded by Contractor's personnel at the place shown by Order Manager/Engineer-in charge.

The Contractor shall so arrange that all the scrap generated during the progress of his work, is separated into two categories, viz.

- i) Saleable scrap like steel, copper or other metals, etc., and,
- ii) Others, which have nil or negligible resale value, like insulation material, jute, debris, etc. (or as directed by the Order Manager/Engineer-in charge).

The saleable scrap shall be shifted to and unloaded at a central place as per directions of the Stores-in charge, while the other scraps shall be shifted to other locations as per directions from Order Manager/Engineer-in Charge, or as per terms of the order.

The Contractor shall arrange to remove the scrap on regular basis, or even on daily basis, depending upon the requirement, to keep the area around his workplace neat and tidy. In case, it is observed that the

Contractor is not carrying out regular cleaning of his areas of work, or, is not returning the excess materials/ scrap, etc., to the Stores, Owner reserves the right to arrange the same through other sources, and back-charge the Contractor the cost of doing so, along-with overheads, by deducting the amount from Contractor's bills.

Contractor's final bill will be cleared by Owner only after confirming that proper clearing of his areas of work has been completed by the Contractor, and same is certified by the Order Manager/ Engineer in-charge

33. Tata Code of Conduct

The Owner abides by the Tata Code of Conduct in all its dealing with stake holders and the same shall be binding on the Owner and the Contractor for dealings under this Order/ Contract. A copy of the Tata Code of Conduct is available at our website: <http://www.tatapower.com/aboutus/code-of-conduct.aspx>. The Contractor is requested to bring any concerns regarding this to the notice of our Chief Ethics Officer on the e-mail ID: cecounsellor@tatapower.com.

34. Responsible Supply Chain Management:

The Owner is committed for a cleaner environment and respect of Human rights through its Responsible Supply Chain Management policy. The Contractor is required to comply with all the environment & Human rights related laws, including emission norms, Labour and environmental regulations. The Owner encourages its Vendors/ Contractors/ Business partners to pay more attention to green design, green supply, green production, green logistics and green packaging in performing their business obligations.

The Contractor is required to abide by the Tata Power Corporate Environment policy, Energy Conservation and Corporate Sustainability Policy.

A copy of the Responsible Supply Chain Policy along with Environment policy, Energy Conservation policy, Sustainability policy, Health & Safety policy and Human Rights policy is available at website: <http://www.tatapower.com/sustainability/policies.aspx>.

Contractor/Bidder is required to completely fill the attached "Supplier Sustainability Questionnaire" in support of their Green Supply Chain Management initiatives and submit the same with their offer.

The Owner recognizes that diversity in the workplace positively impacts business. The Owner is committed to help people from SC/ST background either by helping them to become entrepreneurs or by engaging workforce from SC/ST community under the contracts agreed herein. To encourage engaging SC/ST community, the owner may consider on the merit to incentivize the Contractor by paying additional 1% of

the service contract portion if the number of SC/ST workforce engaged in the contract exceeds 30% of the total deployed strength and 2%, if the strength goes beyond 50%. While the Contractor will assist the workforce so engaged to become self-reliant in meeting the work expectation, the Owner may also volunteer its training resources to the extent possible to improve their employability. The Contractor shall maintain the proper documentation of such category of the workforce engaged and the owner may consider to pay the incentive after its verification.

The Owner may also consider extending price preference of 5% in the bid evaluation for an order value up to Rs.50 Lacs, provided the company is owned by a person from SC/ST community having minimum 50% holding in the company.

35. Vendor rating:

You are requested to ensure compliance to the terms of the individual orders with regards to timely delivery, provision of all applicable documents / challans / test certificate, quality of the material etc. Your performance with respect to the said factors will be taken into consideration for future business.

36. Vendor Feedback:

34.1 In this dealing Vendors feedback is important for the purchaser to improve its processes. If Contractor have to report any grievance, problem or require any clarification, information, Contractor is requested to contact purchaser at email ID: CC_CUSTOMERFEEDBACK@tatapower.com

34.2 Contractor is requested to ensure compliance to the terms of the individual orders with regards to timely delivery, provision of all applicable documents / challans / test certificate, quality of the material etc. Contractor performance with respect to the said factors will be taken into consideration for future business.

37. Non-Waiver:

Failure of Owner or its representatives to insist upon adherence to any of the terms or conditions incorporated in the Contract or failure or delay to exercise any right or remedies herein or by law accruing, or failure to promptly notify the Contractor in the event of breach or the acceptance of or the payment of any Material(s) hereunder or approval of any design or Material(s) shall not release the Contractor and shall not be deemed a waiver of any right of Owner to insist upon the strict performance thereof or of any of its rights or remedies as to any

such Material(s) regardless of when the Material(s) are shipped, received or accepted not shall any purported oral modification or revisions of the Contract by Owner or its representative(s) act as waiver of the terms hereof.

ESG FRAMEWORK FOR BUSINESS ASSOCIATES

Tata Power's Sustainability philosophy sits at the core of its Business Strategy. Tata Power Sustainability Model has an overarching objective of 'Leadership with care' with key elements of 'Care for the Environment'; 'Care for the Community'; 'Care for our Customers / Partners' and 'Care for our People'. These sustainability objectives encompass the Environmental, Social and Governance objectives driven as integrated elements.

Tata Power, together with its stakeholders is determined to achieve sustainable growth while creating shared value for all.

As a part of future ready roadmap, Tata Power has targeted following as our Environment, Social and Governance priorities:

- Being Carbon Net Zero before 2045
- Growing Clean capacity (80% by 2030)
- Customer centricity
- Becoming water neutral before 2030
- Achieving zero waste to landfill before 2030
- No net loss of biodiversity before 2030
- Positively impacting 80 million lives by 2027

In order to create a sustainable business ecosystem, Tata Power expects that all its Business Associates (BA) which includes its suppliers, vendors, consultants and service providers to align to its ESG and sustainability commitments.

Tata Power encourages improved efficiencies and scaling up of green initiatives through technology and innovation taking us farther on the journey of reducing carbon emissions and preparing the entire eco-system towards products and services that would have net positive impact on the environment and communities that we operate in.

The Vendors/ bidders wishing to associate with Tata Power are expected to share their own sustainability and ESG journey. We at Tata Power promote all Business Associates to have a sustainable procurement policy for their supplier and service providers to contribute to our integrated approach in achieving a sustainable supply chain. The BA is encouraged to carry out the assessment of their sub-contractors and sub-vendors on sustainability readiness so that they are aware of the expectation/ business requirement.

The Vendor/ Bidder shall fill-in the 'Environment, Social and Governance Compliance Screening Questionnaire for Business Associates' attached at Annexure-I and submit the same along with the Bid in Ariba online platform.

Responsible Supply Chain Management:

Tata Power is committed for a cleaner environment and respect of Human rights through its Responsible Supply Chain Management policy.

Tata Power Business Associate (BA) shall comply with all the environment & Human rights related laws, including emission norms, Labour and environmental regulations.

Tata Power encourages its BA to focus on green design, green supply, green production, green logistics and green packaging in performing their business obligations. The BA is expected to abide by the Tata Power Corporate Environment policy, Energy Conservation and Corporate Sustainability Policy (enclosed with this document as Annexure-II).

The BA is expected to:

- Strive towards Conservation of Energy, Water, Resources and optimize transportation of Men & Materials to minimize environmental impact and reduce carbon footprint.
- Carry out the assessment of materials used for construction, operation & maintenance, consumables and accordingly phase out those materials which are environmentally hazardous.
- Be cognizant that diversity in the workplace positively impacts business.
- Promote affirmative action by supporting people from SC/ ST background by engaging workforce from SC/ ST community under the contracts agreed herein.
- Share the commitment of 'No child labour', 'No forced labour', Non-discrimination on the basis of caste, colour, religion, gender, disability, maternity or pregnancy or any other factor unrelated to the requirements of the job
- Pay the wages or remuneration to the workforce, personnel deployed in compliance to all applicable laws and regulations.
- Provide its employees/ deployed labor with an employment environment that is free of physical or psychological harassment.
- Carry out the assessment of their Sub-contractors on their Sustainability Readiness so that they are aware of the above expectation/ standards
- To ensure usage of suitable package material which is more environmentally sustainable. Further the packing material shall be recycled to the extent possible. The material used for packing is expected to suit the mode of transport and to ensure its safe receipt at point of delivery.

Waste Disposal:

The BA is expected to follow best practices for disposal of waste, few of which are listed below:

- Have a detailed project plan that includes the waste management, segregation of all designated waste material (Recyclable/ Non-Recyclable), collecting, storing, disposing and transferring the same to pre-arranged facility/ destination in timely and safe manner as per environmental legislations. The project plan shall also include the innovative construction practice to eliminate or minimize waste, protect surface/ground water, control dust and other emissions to air and control noise.
- Have purchase policy to encourage the procurement of material with recycled and minimum packaging of goods during delivery and appropriate means for site-to-site transportation of materials to avoid damage and litter generation.
- Ensure that the residents living near the site are kept informed about proposed working schedule and timings/ duration of any abnormal noise full activity that is likely to happen.
- Ensure the regular maintenance and monitoring of vehicles and equipment for efficient fuel use so that emissions and noise are within acceptable limits to avoid air pollution.

Water Management:

The BA is expected to follow best practices for water management, few of which include a management and monitoring system for water withdrawals and consumption, procedures to reduce water usage or reuse/recycle water, and pretreatment of wastewater before disposal.

Compliance to Law:

The BA shall adhere to responsible business practices and comply with the provision of all the Statutory Acts Applicable. Special attention of the BA is drawn towards the compliance of provision of the following statues: (along with the latest amendments/additions, as applicable):

- The Child Labour (Prohibition and Regulation) ACT, 1986.
- The Contract Labour (Regulation and Abolition) ACT, 1970.
- The Employee's Pension Scheme, 1995.
- The Employee's Provident Funds and miscellaneous provisions Act, 1952.
- The Employees State Insurance Act, 1948.
- The Equal Remuneration Act, 1976.
- The Industrial Disputes Act, 1947.
- The Maternity Benefit Act, 1961.
- The Minimum Wages Act, 1948.
- The Payment of Bonus Act, 1965
- The Payment of Gratuity Act, 1972.
- The Payment of Wages Act, 1936.
- The Shops & Establishment Act, 1954.
- The Workmen's Compensation Act, 1923.
- The Employer's Liability Act, 1938.
- and any other applicable statutory act

Social Accountability (SA 8000):

Tata Power expects its BAs to follow guidelines of SA 8000:2014 on the following aspects

- Child Labour
- Forced or Compulsory Labour
- Health & Safety
- Freedom of Association & Right to Collective Bargaining
- Discrimination
- Disciplinary Practices
- Working Hours
- Remuneration
- Management System

Health and Safety

The BA is expected to ensure the health and safety of his and his Sub-contractor's staff and labour. The BA shall, in collaboration with and according to the requirements of the local health authorities, ensure that medical staff, first aid facilities, sick bay and ambulance service are available at the accommodation and on the Site at all times, and that suitable arrangements are made for all necessary welfare and hygiene requirements and for the prevention of epidemics. The BA shall maintain records and make reports concerning health, safety and welfare of persons deployed, and damage to property, as the Owner's Representative may reasonably require. The BA shall be responsible for the medical treatment / hospitalization of his and his Sub-contractor's staff/ labour.

The BA shall appoint a qualified Safety officer at the Site to be responsible for maintaining the safety, and protection against accidents, of all personnel on the Site. Such Safety officer shall have the authority to issue instructions and take protective measures to prevent accidents.

The BA shall comply in toto with the Tata Power's Contractor Safety Terms & Conditions, Health Safety & Environment Manual while working on Tata Power Site/ Services/ Contracts.

Grievance Mechanism

The BA is expected to have grievance procedures that allow stakeholders to anonymously bring environmental and/or work-related violations and/or concerns to the attention of management. In addition, the BA is expected to have procedures for examining reports of environmental and/or work-related violations or concerns and/or privacy complaints.

Data Protection

The BA is expected to have a formal process to address data security or privacy issues.

ANNEXURE-I



Sr. No.	Question Description	Response (Y/N)	Remarks
Organization			
1	Does your Company have Sustainability Policy at Organization Level? If Yes, Please attach		
2	Do you have sustainable procurement policy in place for your own suppliers? If Yes, Please attach		
3	Does your company do regular assessment of its suppliers on ESG parameters?		
4	Are there ESG risks, or negative impacts identified in your supply chain		
Governance			
1	Is diversity taken into consideration when appointing board members/ senior management? Do you have an independent director/s?		
2	Has your company taken initiatives to ensure ethical practices at workplace? Please share the details, Policies etc.		
3	Does your company have a formal process to address data security or privacy issues? Please share the details, Policies etc.		
4	Does your company have grievance mechanism for stakeholder issues and track resolution?		
Environment/ Planet			
1	Does your company have Environmental Policy? If Yes, Please attach		
2	Do you have a formal process for waste management including solid wastes, liquid wastes and hazardous waste?		
3	Does your company track greenhouse gas emission? Also, what percentage of own consumption comes from the renewable energy?		
4	Does your company have a formal process for water management including monitoring of water consumption and withdrawals, and if applicable, pretreatment of wastewater?		
Green Technology/ Innovation			
1	Are your facility/ Product/ Services provided by you is based on green design, green production, green packaging or green logistics considerations? Please elaborate.		
2	Do your products or services have any environmental or social features or benefits (e.g. environmental/energy certification, ecolabels, fair trade certification, etc.)?		
Social/ People			
1	Does you facility/ Company have written personnel policies in place Are you an equal opportunity employer?		
2	Please describe any formal programme / campaign in place to promote company involvement with the community (volunteering, etc.). What is the percentage of profit spend on community activities?		
3	Does your company have a written Health & Safety Policy or Program? If Yes, Please attach		
Certifications: Does your company have following certifications (valid till date-please mention validity)			
1	ISO9001 accreditation		
2	SA8000 or equivalent		
3	ISO 14001 certification		
4	ISO 18001/45001 or equivalent		
5	ISO/IEC 27001 or equivalent		
6	Any Other (Please specify)		

Signature

Business Associate Name

ANNEXURE-II

CORPORATE SUSTAINABILITY POLICY

At Tata Power, our Sustainability Policy integrates economic progress, social responsibility and environmental concerns with the objective of improving quality of life. We believe in integrating our business values and operations to meet the expectations of our customers, employees, partners, investors, communities and public at large

- We will uphold the values of honesty, partnership and fairness in our relationship with stakeholders
- We shall provide and maintain a clean, healthy and safe working environment for employees, customers, partners and the community
- We will strive to consistently enhance our value proposition to the customers and adhere to our promised standards of service delivery
- We will respect the universal declaration of human rights, International Labour Organization's fundamental conventions on core labour standards and operate as an equal opportunities employer
- We shall encourage and support our partners to adopt responsible business policies, Business Ethics and our Code of Conduct Standards
- We will continue to serve our communities:
 - By implementing sustainable Community Development Programmes including through public/private partnerships in and around our area of operations
 - By constantly protecting ecology, maintaining and renewing bio-diversity and wherever necessary conserving and protecting wild life, particularly endangered species
 - By encouraging our employees to serve communities by volunteering and by sharing their skills and expertise
 - By striving to deploy sustainable technologies and processes in all our operations and use scarce natural resources efficiently in our facilities
 - We will also help communities that are affected by natural calamities or untoward incidence, or that are physically challenged in line with the Tata Group's efforts

The management will commit all the necessary resources required to meet the goals of Corporate Sustainability.



(Praveer Sinha)
CEO & Managing Director

Date: 15th June, 2018

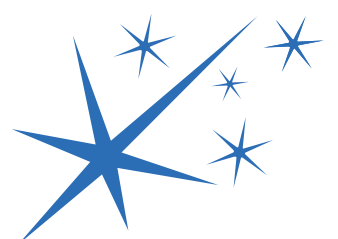

Supplier Code of Conduct

Tata Power follows the Tata Code of Conduct (TCoC) and the Whistle blower Policy and expect all its Suppliers to adhere to the same principles. “Supplier” here means any business, company, corporation, person or other entity that provides, sells or seeks to sell, any kind of goods or services to Tata Power, including the Supplier’s employees, agents and other representatives.

Tata Code of Conduct- (TCoC): <https://www.tatapower.com/pdf/aboutus/Tata-Code-of-Conduct.pdf>

Whistle Blower Policy: <https://www.tatapower.com/pdf/aboutus/whistle-blower-policy-and-vigil-mechanism.pdf>

Anti-Bribery & Anti-Corruption Policy: <https://www.tatapower.com/pdf/aboutus/abac-policy.pdf>

The suppliers are expected to adhere to the following Do’s and Don’ts:

Do’s

1. The Suppliers shall be committed to supplying products and services of high quality that meet all applicable standards and laws, including product packaging, labelling and after-sales service obligations.
2. Comply with all applicable laws and regulations, both in letter and in spirit, in all the territories in which it operates.
3. Strive to provide a safe, healthy and clean working environment for its employees.
4. Strive for environmental sustainability, particularly with regard to the emission of greenhouse gases, consumption of water and energy and the management of waste and hazardous materials.
5. The Supplier shall represent our company (including Tata brand) only with duly authorised written permission from our company.
6. Safeguard the confidentiality on the use of intellectual property, information and data of the Company.
7. Gifts and hospitality given or received should be modest in value and appropriate as per Company Policy.
8. The assets of Tata Power shall be employed primarily and judiciously for the purpose of conducting the business for which they are duly authorised.
9. All actual or potential conflicts due to financial or any other relationship with a Tata Power employee shall be disclosed.

Don’ts

1. The Supplier shall not make unfair or misleading statements about the products and services of competitors.
2. Children shall not be employed at workplaces.
3. Forced labour shall not be used in any form.
4. The Suppliers shall neither receive nor offer or make, directly or indirectly, any illegal payments, remunerations, gifts, donations or comparable benefits that are intended, or perceived, to obtain uncompetitive favours for the conduct of its business with Tata Power.

Reporting Violations

The Supplier shall notify the Company regarding any known or suspected improper behaviour of other suppliers or employees relating to its dealings with Tata Power, by email to: cecounsellor@tatapower.com. The same can also be raised through our 3rd party ethics helpline facility:

Toll-free Number	1800 267 4065
Email	tatapower@tip-offs.in
Website & Chatbot	www.tatapower.tip-offs.in
Postal address	Attn to: Mr. Puneet Arora, Deloitte Touch Tohmtsu India LLP, 6 floor, AIPL Business, Sector 62, Gurugram, Haryana 122102

The Tata Power Company Limited is hereunder referred to as the "Purchaser" or "Company". The person, firm or company selling the goods, the subject of this purchase order is referred to as "Vendor" or "Contractor". The subject of this purchase order is hereinafter referred to as the "Material(s)" or "Goods".

The Contract shall mean the contract as derived from the following:

1. Purchase Order (with 'Commercial Notes' and Annexures to the Purchase Order referred thereon)
2. Technical Specifications.
3. General Terms & Conditions

The documents including all reference document (s) and Annexures forming the Contract are to be read together as a whole and are to be taken as mutually explanatory.

1. Price:

Unless otherwise specifically stipulated, the price shall be firm and shall not be subject to escalation for any reason till the validity of this Contract.

Unless otherwise specifically stipulated, the price shall be inclusive of road/ rail worthy water-proof packing & forwarding charges up to effecting delivery at FOT/ FOR despatch point, GST and shall also be inclusive of inland freight, terminal taxes and entry taxes as leviable on the transportation or entry of goods into any local area limits pursuant to the Contract.

2. Taxes and Duties:

- 2.1 The Contract Price shall be inclusive of all taxes, duties, including but not limited to GST or any local taxes, levies imposed by State/Central/Local governments
- 2.2 Taxes as mentioned in the Contract Price or Price Schedule shall be paid to the contractor subject to the Contractor complying with all the statutory requirements and furnishing the relevant documents including error free invoices containing detailed break-up of the taxes
- 2.3 However the payment of GST or local levies shall be restricted to the total amount as indicated in the price schedule.
- 2.4 Any duties, levies or taxes not mentioned in Contract Price or Price Schedule but applicable as per any statute (s) shall be deemed to be

Rev. date: 25 July 2017

included in the Contract price and shall be to the account of the Contractor.

- 2.5 Any statutory variation in duties, levies or taxes if applicable and specified in this Contract till the scheduled date for supply of Goods and limited to direct invoices of the Contractor shall be to the account of Purchaser. The Contractor shall have the obligation to provide the necessary documentary evidence / supporting by way of gazetted notifications etc. to prove the change in such levies or taxes between the due date of submission of the Bid and the scheduled date of supply of goods to claim the difference.
- 2.6 The Contractor shall pass on to the Purchaser all the benefits of either reduction in tax rates, exemptions, concessions, rebate, set off, credits etc. or introduction of new tax rates exemptions, concessions, rebate, set off, credits etc. pertaining to all taxes, duties, imposts, fees and levies in respect of the supplies of Goods or performance of obligations under the contract. This would specifically include reduction of tax rates as a result of statutory changes or judicial rulings.
- 2.7 Any other taxes, levies and duties not mentioned in Contract Price or Price Schedule but applicable as per any statute (s) or introduction (omission) of new taxes, levies and duties shall be deemed to be included in the Contract Price and shall be to the account of the Contractor.
- 2.8 For facilitating availment of a credit, set-off, rebate, drawback or like benefit available to the Purchaser, the Contractor will facilitate the Purchaser by providing the necessary documentary and/or procedural support. In any process of assessment or re-assessment, of taxes payable by the Purchaser. Wherever expressly agreed the purchaser would provide the statutory form 'C' to the seller for availing the concessional rate of Central sales tax.
- 2.9 The Contractor shall bear and pay all the costs, liabilities, levies, interest, penalties in respect of non-compliances of any legal requirements as per various statutory provisions. The contractor shall keep the owner indemnified at all times from any tax liability, interest, penalties or assessments that may be imposed by the statutory authorities for non-compliances or non-observation of any statutory requirements by the Contractor.
- 2.10 Purchaser shall pay the invoices to the Vendor after necessary deductions as prescribed under the applicable law, income - tax or other

deductions under the State Tax laws as may be applicable to the Contract.

3 Packing details:

Packing details: The material must be packed in suitable packing to suit the mode of transport and to ensure its safe receipt at point of delivery. Any damage to material noticed at the time of delivery at site, due to improper packing or any other reason whatsoever shall be the responsibility of the Vendor. Such damaged goods shall be replaced within 14 days from intimation from the Purchaser.

4 Transportation and Unloading at Site:

The Vendor shall deliver the Material(s) at site/ Stores as per the delivery address specified in the Purchase order. The unloading at delivery shall be organised by the Purchaser unless otherwise specified. The receipt of the material/ equipment is subject to inspection and rejection if Material(s) is found unsatisfactory or any of the clauses under this purchase order are violated.

5 Insurance:

Unless otherwise specified, Purchaser will be responsible to obtain transit insurance for the Material(s). The Vendor shall intimate the Order Manager (as mentioned in the Purchase Order) along with Invoice, packing list, the Railway Receipt/Truck or Lorry Receipt etc. immediately after the consignment is booked, at the e-mail id mentioned in the Purchase order.

6 Payment Terms:

100% payment shall be made within 60 days from the receipt and acceptance of the material at the Consignee Stores/ Site/ Location as per the Contractual terms and conditions herein.

7 Bills and invoice:

The tax invoices should contain the details to comply with the GST Law. The supplier shall:

- i) Furnish (electronically) and communicate to the Owner, the details of Goods or Services supplied by the 10th of the month succeeding the said tax period,
- ii) Upon discovery of any discrepancy, rectify it and shall pay the tax and interest thereof,
- iii) Furnish the returns (electronically), for the inward and outward supplies of

Goods and/or Services, before the specified dates as per the GST Law,
iv) Communicate the tax paid, credits etc. as and when credited.

v) The Invoice should clearly state the description of the goods, quantity, sale price, tax %, and tax amount;

vi) The Invoice should be signed by an Authorized Signatory.

Bills/Invoices in the name of The Tata Power Company Ltd. with packing lists in triplicate shall be forwarded along with the equipment.

Contractor to furnish GST Registration no. in all invoices as well as Purchaser's (Tata Power's) GST no.

8 Transfer of Title and risk:

The transfer of property and risk of Material(s) shall be deemed to take place as follows:

a. For delivery F.O.R. or F.O.T. despatch point: Transfer of property on handing over the Material(s) to the carrier against receipt of clean Railway Receipt/Truck or Lorry Receipt and such receipt having been handed over to Purchaser. However, the risk of loss shall pass to the Purchaser on delivery of goods at the specified destination.

b. In case the Material(s) are procured by the Vendor from sub-vendors on receipt of duly endorsed documents of title to the goods.

9 Contract Performance Bank Guarantee (In case applicable):

9.1 The Vendor shall within 15 days of issue of this Purchase Order furnish an unconditional irrevocable bank guarantee duly stamped and strictly as per the prescribed format of the Purchaser from any nationalized bank or any scheduled bank having a branch in Mumbai and approved by the Purchaser for a sum equivalent to 10% of the Total value of Order valid for a period not less than 6 months from the expiry of the Warranty period.

9.2 Irrespective of the performance demonstrated as part of the Factory Acceptance Tests Take-over tests / Performance Tests etc, the Purchaser may call for re-validation of performance of the system during the performance guarantee period by conducting fresh performance tests if in its opinion, the

system is not able to deliver the designed performances based on its operational performance results. If the equipment fails to prove the performance during such performance tests, the Purchaser may allow the Vendor to either rectify the system by addition / modification of equipment etc at the Vendor's costs & risk to restore the performance levels. Failure to rectify the system to achieve the designed performance levels may result in imposition of penalties including revocation of the Performance Bank Guarantee and forfeiture of the entire amount under the Performance Guarantee.

- 9.3 In case the Vendor fails to furnish the requisite Bank Guarantee as stipulated above, then the Company shall have the option to terminate the contract besides other contractual remedies.

10 Price reduction:

- 10.1 The Vendor agrees that time of supply of Material(s) is of prime importance. If the Vendor fails to supply Material(s) before the respective scheduled / fixed date for supply. Company may without prejudice to any other right or remedy available to the Company: -

10.1.1 Recover from the Vendor ascertained and agreed, genuine pre-estimate liquidated damages, and not by way of penalty, a sum equivalent to 1% (of total value of order) per week or part thereof for each week's delay, beyond the scheduled supply date each subject to maximum of 10% of the total order value, even though the Company may accept delay in supply after the expiry of the scheduled supply date. The Company may, at its discretion, set off the aforesaid amounts from any other amounts owed by the Company to the Vendor or recover such amounts in other manner as may be permissible under applicable laws.

10.1.2 Arrange to get supply from elsewhere on account and at the sole risk of the Vendor, such decision of the Company being final and binding on the Vendor; or

10.1.3 Terminate the contract or a portion of supply of the supply work thereof, and if so desired, arrange for the supply in default by the Vendor to be attained from elsewhere at the sole risks and costs of the Vendor.

10.2 Liquidated damages for performance shortfall (if applicable) shall be specified in the Technical Specifications.

10.3 The Liquidated Damages referred in this clause 10 may be recovered by the Company from the Vendor as set off against any monies owed by the Company to the Vendor or in any other manner permissible under applicable laws.

11 Warranties:

11.1 Materials and Workmanship: Vendor shall fully warrant that all the stores, equipment and component supplied under the order shall be new and of first class quality according to the specifications and shall be free from defects (even concealed fault, deficiency in design, materials and workmanship).

11.2 Should any defects be noticed in design, material and/or workmanship within 12 months after the Material(s) or any portion thereof as the case may be have been commissioned or for 24 months from the date of delivery, whichever period concludes earlier. Purchaser shall inform Vendor and Vendor shall immediately on receipt of such intimation, depute their personnel within 7 days to investigate the causes of defects and arrange rectification/ replacement/modification of the defective equipment at site, without any cost to Purchaser within a reasonable period. If the Vendor fails to take proper corrective action to repair/replace defects satisfactorily within a reasonable period, Purchaser shall be free to take such corrective action as may be deemed necessary at Vendor's risk and cost after giving notice to the Vendor, including arranging supply of the Goods from elsewhere at the sole risk and cost of the Vendor.

11.3 In case defects are of such nature that equipment shall have to be taken to Vendor's work for rectification etc., Vendor shall take the equipment at his costs after giving necessary undertaking or security as may be required by Purchaser. After repair Vendor shall deliver the equipment at site on freight paid basis. Any taxes applicable in relation to this repair shall be to the Vendor's account. All risks in transit to and fro shall be borne by the Vendor.

11.4 Equipment or spare parts thereof replaced shall have further warranty for a period of 12 months from the date of acceptance.

12 Quality, Testing, inspection, installation:

12.1 All Material(s) supplied under this Contract shall be new and unused.

- 12.2 Wherever a specific Quality Assurance Plan is provided with the Request for Quotation (RFQ) or agreed as part of the commercial/ technical discussions, the same shall be binding on the Vendor.
- 12.3 The material shall be inspected
- a. At consignee end by Purchaser.
 - b. At factory premise of the Vendor/ sub-vendor by Purchaser or third party duly nominated by Purchaser. The Vendor shall extend all necessary co-operation to Purchaser/ third party inspector carrying out the inspection. The Inspector(s) shall have the right to carry out the inspection or testing, which will include inspection and testing of the raw materials at manufacturers shop, at fabricators shop and at the time of actual despatch before and/or after completion of packing.
- 12.4 The Vendor will inform Purchaser at least eight (8) days in advance of the exact place, date and time of tendering the Material(s) for required inspection and provide free access to the Inspector(s) during normal working hours at Vendor's or his/ its sub-Suppliers works, and place at the disposal of the Inspector(s) all useful means for undertaking the Inspection, checking the results of tests performed, marking the Material(s), getting additional tests conducted and final stamping of the Material(s).
- 12.5 Even if the inspection and tests are fully carried out, the Vendor shall not be absolved from its responsibilities to ensure that the Material(s), raw materials, components and other inputs are supplied strictly to conform and comply with all the requirements of the Contract at all stages, whether during manufacture and fabrication, or at the time of Delivery as on arrival at site and after its erection or start up or consumption, and during the defect liability period. The inspections and tests are merely intended to prima facie satisfy Purchaser that the Material(s) and the parts and components comply with the requirements of the Contract.
- 12.6 *All costs associated with the inspection shall be included in cost of Material(s).*
- 12.7 Original material test certificate/ performance test certificate/ fitment certificate/ test reports etc. relevant/ applicable as per the specifications/ standards shall be dispatched along with the material supply failing which the material may be rejected.
- 13 Rejection:**
- 13.1 Rejected goods shall be removed and replaced within 14 days of the date of communication of rejection.
- 13.2 Claim in respect of breakage/shortages in any cases shall be referred on the Vendor within ninety (90) days from the date of receipt of Goods by the Purchaser which shall be replaced/made good by the Vendor at his own cost. All risk of loss or damage to the material shall be upon the Vendor till it is delivered to the purchaser/consignee.
- 14 General Indemnity:**
- The Vendor shall indemnify and keep the Purchaser indemnified from and against any and all claims, costs, liabilities (financial), litigations, compensations, judgments, expenses or damages (including attorney's fees and other related expenses) arising out of any breach or alleged breach of any of the conditions of this Contract, performance of the obligations hereunder, or any representation or misrepresentation made by the Vendor or any third party with regard to the subject of this Contract.
- 15 Indemnity against IPR:**
- The equipment, system, drawings, and other materials that shall be supplied against the order will become the Purchaser's property. Without limitation of any liability of whatsoever nature, the Purchaser shall be indemnified and kept indemnified against any claim for infringement or breach of any of the statues, rules & regulations by the use of or sale of any article or material supplied by the Vendor. The indemnity shall include any infringement of patent, trade mark, design, copyright or other property rights whether in Country of Origin, or elsewhere resulting from the Vendor's design, manufacture, use, supply or re-supply & would also cover use or sale of any article or material supplied by the Vendor to the Purchaser under the Purchase Order. The Indemnity shall cover any claim/action taken by a third party either directly against the Purchaser or any claim/action made against the Vendor & where under the Purchaser is made liable. The

Indemnity shall be for losses, damages, and costs including litigation costs, attorney fees etc incurred by the Purchaser in relation to the Purchase Order.

16 Latent Defects Liability period (if applicable):

Notwithstanding the inspections, acceptance tests, quality checks etc carried out by the Vendor and witnessed/accepted by the Purchaser, the Vendor shall further warrant the equipment for any latent defects in its design, material or workmanship against the specifications set forth and shall make good any such defects by way of repair or replacement of the part or whole of the defective product at its own cost & risks as and when such latent defects are observed and intimated by the Purchaser and intimated to the Vendor within 36 months of completion of warranty period.

17 Force Majeure:

- 17.1 In the event of either party being rendered unable by force majeure to perform any obligation required to be performed by it under this Contract the relative obligation of the party affected by such force majeure shall, after notice under this articles be suspended for the period during which such cause lasts. The term 'Force Majeure' as employed herein shall mean acts of God, wars (declared or undeclared), riots or civil commotion, fire, floods, and acts and regulations of the Government of India or State Government or any of the statutory agencies. Both the party shall pay to the other party, the amount payable upon the date of the occurrence of such force majeure.
- 17.2 Upon the occurrence of such cause and upon its termination, the party alleging that it has been rendered unable as aforesaid, thereby shall notify the other party in writing immediately but not later than twenty four (24) hours of the alleged beginning and ending thereof giving full particulars and satisfactory evidence in support of the claims.
- 17.3 During the period, the obligations of the parties are suspended by force majeure, the contractor shall not be entitled to payment of any rate.
- 17.4 In the event of the force majeure conditions continuing or reasonably expected to continue for a period more than thirty (30) days, Purchaser shall have the option of terminating the contract by giving seven (7) days notice thereof to the contractor.

18 Variation:

Except for any provisions in this Purchase Order, any change /modification to the terms and conditions of this Order can be issued only by Purchaser or with the prior written approval from Purchaser.

19 Termination

- 19.1 The Contract shall be deemed to be terminated on completion of delivery of Material(s)
- 19.2 Termination of Default by Vendor:
Purchaser may terminate the contract at any time if the Vendor fails to carry out any of his obligations including timely delivery under this Contract. Prior to termination, the Vendor shall be advised in writing of the causes of unsatisfactory performance to be improved upon 15 days of the receipt of notice. In case, if the Vendor fails to bring about the improvement to the satisfaction of the Purchaser, then the order shall be terminated.
- 19.3 Without prejudice to the rights and remedies available to Purchaser, Purchaser may terminate the Contract or part thereof with immediate effect with written notice to the Vendor if,:
- 19.3.1 The Vendor becomes bankrupt or goes into liquidation.
- 19.3.2 The Vendor makes a general assignment for the benefit of creditors.
- 19.3.3 A receiver is appointed for any substantial property owned by the Vendor.
- 19.3.4 The Vendor has misrepresented to Purchaser, acting on which misrepresentation Purchaser has placed the Purchase Order on the Vendor.

The Vendor/ Contractor shall not be entitled to any further payment under the Contract if the Contract is terminated. If the order is terminated under clause 19.2 and 19.3, the Vendor shall not be entitled to any further payment, except that, if Purchaser completes the supply of Material(s) and the costs of completion are less than the Total Order value, the Purchaser shall pay Vendor an amount properly allocable to supply of Material(s) fully performed by Vendor prior to termination for which payment was not made to Vendor. In case, the cost of completion of Material(s) exceed the total Order value, the additional cost incurred by Purchaser for such completion shall be paid by the Vendor.

19.4 Purchaser shall be entitled to terminate the Contract at its convenience, at any time by giving thirty (30) Days prior notice to the Contractor. Such notice of termination shall specify that termination is for Companies convenience and the date upon which such termination becomes effective. Upon receipt of such notice, the Contractor shall proceed as follows:

- 19.4.1 cease all further work, except for such work as may be necessary and instructed by the Company/ Company's representative for the purpose of protecting those parts of the supplies already manufactured;
- 19.4.2 stop all further sub-contracting or purchasing activity, and terminate Sub-contracts;
- 19.4.3 handover all Documents, equipment, materials and spares relating to the supply of goods prepared by the Contractor or procured from other sources up to the date of termination for which the Contractor has received payment equivalent to the value thereof; and
- 19.4.4 handover those parts of the supplies manufactured by the Contractor up to the date of termination.

Upon termination pursuant to clause 19.4, the Vendor shall be entitled to be paid the full value on the Material(s) delivered in accordance with the Contract.

19.5 The Contractor shall not be released from any of his obligations or liabilities accrued under the Contract on termination. For the avoidance of doubt, the termination of the Contract in accordance with this clause shall neither relieve the Contractor of his accrued obligations for Warranty or his accrued liability to pay (liquidated) damages for Delay nor shall entitle him to reduce the value of Performance Security.

20 Sub letting and assignment:

The contractor shall not without prior consent in writing of the Purchaser, sublet, transfer or assign the contract or any part thereof or interest therein or benefit or advantage thereof in any manner whatsoever, provided nevertheless that any such consent shall not relieve the contractor from any obligation, duty or responsibility under the contract.

21 Dispute Resolution:

Dispute or differences arising out or relating to this Order shall be resolved amicably by the parties. Failing such amicable resolution of dispute / differences either party may refer the matter to arbitration of a Sole Arbitrator to be appointed jointly by both the parties. The award of the Arbitrator shall be final, binding and conclusive on the parties. The venue for arbitration shall be Mumbai. The Arbitration proceedings will be governed and regulated by the provisions of Indian Arbitration and Conciliation Act, 1996 as amended from time to time and the rules framed there under.

22 Governing laws

This Contract shall be construed in accordance with and governed by the Laws of India without giving effect to any principle of conflict of law.

23 Jurisdiction

This Contract and the transaction contemplated herein shall be subject to the exclusive jurisdiction of the competent Courts in Mumbai only.

24 Limitation of Liability

Notwithstanding anything contained in the Contract, the Contractor's aggregate liability under this Contract shall be limited 100% of the Total order value. This shall however, exclude liability arising pursuant to clause 2.8- tax indemnity, clause 14- General Indemnity, clause 15- Indemnity against IPR, clause 25 – Confidentiality and liabilities arising due to wilful misconduct, gross negligence, third party claims and corrupt acts attributable to the Vendor.

25 Confidentiality:

The Vendor shall use the Confidential Information of the Purchaser only in furtherance of this Contract and shall not transfer or otherwise disclose the Confidential Information to any third party. The Vendor shall (i) give access to such Confidential Information solely to those employees with a need to have access thereto; and (ii) take the same security precautions to protect against disclosure or unauthorized use of such Confidential Information that the party takes with its own confidential information but, in no

event, shall a party apply less than a reasonable standard of care to prevent such disclosure or unauthorized use.

26 Consequential Damages:

Unless otherwise specified, neither Party shall be responsible for and nor shall be liable to the other Party for indirect/consequential losses and damages suffered by such Party including for loss of use, loss of profit whether such liability or claims are based upon any negligence on the part of the other Party or its employees in connection with the performance of the Purchase Order.

27 New Legislation (The Micro, Small and Medium Enterprise Development Act 2006)

- a. This Act has been enacted and made effective from 2nd October 2006. The Interest on Delayed Payments to Small Scale and Ancillary Industrial Undertaking Act, 1993 is repealed.
- b. Vendor is requested to inform the purchaser if vendor fall under The Micro, Small and Medium Enterprises Development Act, 2006 legislation and provide the purchaser, registration number and date to enable purchaser to take necessary care. The vendors are also requested to mention the same on their invoice / bill.

28 Relation between parties:

The Purchase Order shall be entered into on a principal-to-principal basis only. The Purchase order shall not be construed as a partnership or an association of persons. There is no agent and principal relationship between the parties. Each party shall be responsible for its own conduct. The Vendor shall ensure at all times that all the work carried out under this contract either by its own person or through any of its sub-Vendors shall be always done under its own direct supervision.

29 Environment / ISO 14001 Certification:

The Vendor to confirm whether their organization is ISO 14001 certified. If not, the Vendor must certify that the handling, use and disposal of their product / by-products conform to practices consistent with sound environmental management and local statutes. The Vendor shall ensure that all the wastes are disposed in environmental friendly way with strict compliance to applicable laws including

adherence to MoEF guidelines with respect to disposal of batteries, lead waste, copper cables, ash, waste oil, e-waste etc which shall be disposed through MoEF approved parties only. The Vendor shall also be responsible to collect and recycle all the e-waste generated at the end of the product life cycle at its own costs and risks as per the MoEF guidelines/ orders.

30 Tata Code of Conduct

The Purchaser abides by the Tata Code of Conduct in all its dealing with stake holders and the same shall be binding on the Purchaser and the Vendor for dealings under this Purchase Order. A copy of the Tata Code of Conduct is available at our website: <http://www.tatapower.com/aboutus/code-of-conduct.aspx>. The Vendor is requested to bring any concerns regarding this to the notice of our Chief Ethics Officer on the e-mail ID: cecounsellor@tatapower.com.

31 Responsible Supply Chain Management:

The Purchaser is committed for a cleaner environment and respect of Human rights through its Responsible Supply Chain Management policy. The Vendor is required to comply with all the environment & Human rights related laws, including emission norms, Labour and environmental regulations. The Purchaser encourages its Vendors/ Contractors/ Business partners to pay more attention to green design, green supply, green production, green logistics and green packaging in performing their business obligations.

The Vendor is required to abide by the Tata Power Corporate Environment policy, Energy Conservation and Corporate Sustainability Policy.

A copy of the Responsible Supply Chain Management Policy along with Environment policy, Energy Conservation policy, Sustainability policy, Health & Safety policy and Human Rights policy is available at website: <http://www.tatapower.com/sustainability/policies.aspx>.

Vendor/Bidder is required to completely fill the attached "Supplier Sustainability Questionnaire" in support of their Green Supply Chain Management initiatives and submit the same with their offer.

The Owner recognizes that diversity in the workplace positively impacts business. The Owner is committed to help people from SC/ST background either by helping them to become entrepreneurs or by engaging workforce from SC/ST community under the contracts agreed herein. To encourage engaging SC/ST community, the owner may consider on the merit to incentivize the Contractor by paying additional 1% of the service contract portion if the number of SC/ST workforce engaged in the contract exceeds 30% of the total deployed strength and 2%, if the strength goes beyond 50%. While the Contractor will assist the workforce so engaged to become self-reliant in meeting the work expectation, the Owner may also volunteer its training resources to the extent possible to improve their employability. The Contractor shall maintain the proper documentation of such category of the workforce engaged and the owner may consider to pay the incentive after its verification.

The Owner may also consider extending price preference of 5% in the bid evaluation for an order value up to Rs.50 Lacs, provided the company is owned by a person from SC/ST community having minimum 50% holding in the company.

32 Vendor rating

You are requested to ensure compliance to the terms of the individual orders with regards to timely delivery, provision of all applicable documents / challans / test certificate, quality of the material etc. Your performance with respect to the said factors will be taken into consideration for future business.

33 Vendor Feedback:

- 33.1 In this dealing Vendors feedback is important for the purchaser to improve its processes. If vendor have to report any grievance, problem or require any clarification, information, vendor is requested to contact purchaser at email ID: CC_CUSTOMERFEEDBACK@tatapower.com
- 33.2 Vendor is requested to ensure compliance to the terms of the individual orders with regards to timely delivery, provision of all applicable documents / challans / test certificate, quality of the material etc. Vendor performance with

respect to the said factors will be taken into consideration for future business.

34 Non-Waiver:

Failure of Purchaser or its representatives to insist upon adherence to any of the terms or conditions incorporated in the Contract or failure or delay to exercise any right or remedies herein or by law accruing, or failure to promptly notify the Vendor in the event of breach or the acceptance of or the payment of any Material(s) hereunder or approval of any design or Material(s) shall not release the Vendor and shall not be deemed a waiver of any right of Purchaser to insist upon the strict performance thereof or of any of its rights or remedies as to any such Material(s) regardless of when the Material(s) are shipped, received or accepted not shall any purported oral modification or revisions of the Contract by Purchaser or its representative(s) act as waiver of the terms hereof.

35 Repeat Order:

Purchaser may place the repeat order for 100% of ordered quantities within a span of 6 months from the date of issue of this Purchase Order & Vendor shall execute it at same rates, terms and conditions.

36 Severability

If any provision of this Contract is invalid, unenforceable or prohibited by law, this Contract shall be considered divisible as to such provision and such provision shall be inoperative and shall not be part of the consideration moving from any Party hereto to the others, and the remainder of this Contract shall be valid, binding and of like effect as though such provision was not included herein.

ESG FRAMEWORK FOR BUSINESS ASSOCIATES

Tata Power's Sustainability philosophy sits at the core of its Business Strategy. Tata Power Sustainability Model has an overarching objective of 'Leadership with care' with key elements of 'Care for the Environment'; 'Care for the Community'; 'Care for our Customers / Partners' and 'Care for our People'. These sustainability objectives encompass the Environmental, Social and Governance objectives driven as integrated elements.

Tata Power, together with its stakeholders is determined to achieve sustainable growth while creating shared value for all.

As a part of future ready roadmap, Tata Power has targeted following as our Environment, Social and Governance priorities:

- Being Carbon Net Zero before 2045
- Growing Clean capacity (80% by 2030)
- Customer centricity
- Becoming water neutral before 2030
- Achieving zero waste to landfill before 2030
- No net loss of biodiversity before 2030
- Positively impacting 80 million lives by 2027

In order to create a sustainable business ecosystem, Tata Power expects that all its Business Associates (BA) which includes its suppliers, vendors, consultants and service providers to align to its ESG and sustainability commitments.

Tata Power encourages improved efficiencies and scaling up of green initiatives through technology and innovation taking us farther on the journey of reducing carbon emissions and preparing the entire eco-system towards products and services that would have net positive impact on the environment and communities that we operate in.

The Vendors/ bidders wishing to associate with Tata Power are expected to share their own sustainability and ESG journey. We at Tata Power promote all Business Associates to have a sustainable procurement policy for their supplier and service providers to contribute to our integrated approach in achieving a sustainable supply chain. The BA is encouraged to carry out the assessment of their sub-contractors and sub-vendors on sustainability readiness so that they are aware of the expectation/ business requirement.

The Vendor/ Bidder shall fill-in the 'Environment, Social and Governance Compliance Screening Questionnaire for Business Associates' attached at Annexure-I and submit the same along with the Bid in Ariba online platform.

Responsible Supply Chain Management:

Tata Power is committed for a cleaner environment and respect of Human rights through its Responsible Supply Chain Management policy.

Tata Power Business Associate (BA) shall comply with all the environment & Human rights related laws, including emission norms, Labour and environmental regulations.

Tata Power encourages its BA to focus on green design, green supply, green production, green logistics and green packaging in performing their business obligations. The BA is expected to abide by the Tata Power Corporate Environment policy, Energy Conservation and Corporate Sustainability Policy (enclosed with this document as Annexure-II).

The BA is expected to:

- Strive towards Conservation of Energy, Water, Resources and optimize transportation of Men & Materials to minimize environmental impact and reduce carbon footprint.
- Carry out the assessment of materials used for construction, operation & maintenance, consumables and accordingly phase out those materials which are environmentally hazardous.
- Be cognizant that diversity in the workplace positively impacts business.
- Promote affirmative action by supporting people from SC/ ST background by engaging workforce from SC/ ST community under the contracts agreed herein.
- Share the commitment of 'No child labour', 'No forced labour', Non-discrimination on the basis of caste, colour, religion, gender, disability, maternity or pregnancy or any other factor unrelated to the requirements of the job
- Pay the wages or remuneration to the workforce, personnel deployed in compliance to all applicable laws and regulations.
- Provide its employees/ deployed labor with an employment environment that is free of physical or psychological harassment.
- Carry out the assessment of their Sub-contractors on their Sustainability Readiness so that they are aware of the above expectation/ standards
- To ensure usage of suitable package material which is more environmentally sustainable. Further the packing material shall be recycled to the extent possible. The material used for packing is expected to suit the mode of transport and to ensure its safe receipt at point of delivery.

Waste Disposal:

The BA is expected to follow best practices for disposal of waste, few of which are listed below:

- Have a detailed project plan that includes the waste management, segregation of all designated waste material (Recyclable/ Non-Recyclable), collecting, storing, disposing and transferring the same to pre-arranged facility/ destination in timely and safe manner as per environmental legislations. The project plan shall also include the innovative construction practice to eliminate or minimize waste, protect surface/ground water, control dust and other emissions to air and control noise.
- Have purchase policy to encourage the procurement of material with recycled and minimum packaging of goods during delivery and appropriate means for site-to-site transportation of materials to avoid damage and litter generation.
- Ensure that the residents living near the site are kept informed about proposed working schedule and timings/ duration of any abnormal noise full activity that is likely to happen.
- Ensure the regular maintenance and monitoring of vehicles and equipment for efficient fuel use so that emissions and noise are within acceptable limits to avoid air pollution.

Water Management:

The BA is expected to follow best practices for water management, few of which include a management and monitoring system for water withdrawals and consumption, procedures to reduce water usage or reuse/recycle water, and pretreatment of wastewater before disposal.

Compliance to Law:

The BA shall adhere to responsible business practices and comply with the provision of all the Statutory Acts Applicable. Special attention of the BA is drawn towards the compliance of provision of the following statues: (along with the latest amendments/additions, as applicable):

- The Child Labour (Prohibition and Regulation) ACT, 1986.
- The Contract Labour (Regulation and Abolition) ACT, 1970.
- The Employee's Pension Scheme, 1995.
- The Employee's Provident Funds and miscellaneous provisions Act, 1952.
- The Employees State Insurance Act, 1948.
- The Equal Remuneration Act, 1976.
- The Industrial Disputes Act, 1947.
- The Maternity Benefit Act, 1961.
- The Minimum Wages Act, 1948.
- The Payment of Bonus Act, 1965
- The Payment of Gratuity Act, 1972.
- The Payment of Wages Act, 1936.
- The Shops & Establishment Act, 1954.
- The Workmen's Compensation Act, 1923.
- The Employer's Liability Act, 1938.
- and any other applicable statutory act

Social Accountability (SA 8000):

Tata Power expects its BAs to follow guidelines of SA 8000:2014 on the following aspects

- Child Labour
- Forced or Compulsory Labour
- Health & Safety
- Freedom of Association & Right to Collective Bargaining
- Discrimination
- Disciplinary Practices
- Working Hours
- Remuneration
- Management System

Health and Safety

The BA is expected to ensure the health and safety of his and his Sub-contractor's staff and labour. The BA shall, in collaboration with and according to the requirements of the local health authorities, ensure that medical staff, first aid facilities, sick bay and ambulance service are available at the accommodation and on the Site at all times, and that suitable arrangements are made for all necessary welfare and hygiene requirements and for the prevention of epidemics. The BA shall maintain records and make reports concerning health, safety and welfare of persons deployed, and damage to property, as the Owner's Representative may reasonably require. The BA shall be responsible for the medical treatment / hospitalization of his and his Sub-contractor's staff/ labour.

The BA shall appoint a qualified Safety officer at the Site to be responsible for maintaining the safety, and protection against accidents, of all personnel on the Site. Such Safety officer shall have the authority to issue instructions and take protective measures to prevent accidents.

The BA shall comply in toto with the Tata Power's Contractor Safety Terms & Conditions, Health Safety & Environment Manual while working on Tata Power Site/ Services/ Contracts.

Grievance Mechanism

The BA is expected to have grievance procedures that allow stakeholders to anonymously bring environmental and/or work-related violations and/or concerns to the attention of management. In addition, the BA is expected to have procedures for examining reports of environmental and/or work-related violations or concerns and/or privacy complaints.

Data Protection

The BA is expected to have a formal process to address data security or privacy issues.

ANNEXURE-I



Sr. No.	Question Description	Response (Y/N)	Remarks
Organization			
1	Does your Company have Sustainability Policy at Organization Level? If Yes, Please attach		
2	Do you have sustainable procurement policy in place for your own suppliers? If Yes, Please attach		
3	Does your company do regular assessment of its suppliers on ESG parameters?		
4	Are there ESG risks, or negative impacts identified in your supply chain		
Governance			
1	Is diversity taken into consideration when appointing board members/ senior management? Do you have an independent director/s?		
2	Has your company taken initiatives to ensure ethical practices at workplace? Please share the details, Policies etc.		
3	Does your company have a formal process to address data security or privacy issues? Please share the details, Policies etc.		
4	Does your company have grievance mechanism for stakeholder issues and track resolution?		
Environment/ Planet			
1	Does your company have Environmental Policy? If Yes, Please attach		
2	Do you have a formal process for waste management including solid wastes, liquid wastes and hazardous waste?		
3	Does your company track greenhouse gas emission? Also, what percentage of own consumption comes from the renewable energy?		
4	Does your company have a formal process for water management including monitoring of water consumption and withdrawals, and if applicable, pretreatment of wastewater?		
Green Technology/ Innovation			
1	Are your facility/ Product/ Services provided by you is based on green design, green production, green packaging or green logistics considerations? Please elaborate.		
2	Do your products or services have any environmental or social features or benefits (e.g. environmental/energy certification, ecolabels, fair trade certification, etc.)?		
Social/ People			
1	Does you facility/ Company have written personnel policies in place Are you an equal opportunity employer?		
2	Please describe any formal programme / campaign in place to promote company involvement with the community (volunteering, etc.). What is the percentage of profit spend on community activities?		
3	Does your company have a written Health & Safety Policy or Program? If Yes, Please attach		
Certifications: Does your company have following certifications (valid till date-please mention validity)			
1	ISO9001 accreditation		
2	SA8000 or equivalent		
3	ISO 14001 certification		
4	ISO 18001/45001 or equivalent		
5	ISO/IEC 27001 or equivalent		
6	Any Other (Please specify)		

Signature

Business Associate Name

ANNEXURE-II

CORPORATE SUSTAINABILITY POLICY

At Tata Power, our Sustainability Policy integrates economic progress, social responsibility and environmental concerns with the objective of improving quality of life. We believe in integrating our business values and operations to meet the expectations of our customers, employees, partners, investors, communities and public at large

- We will uphold the values of honesty, partnership and fairness in our relationship with stakeholders
- We shall provide and maintain a clean, healthy and safe working environment for employees, customers, partners and the community
- We will strive to consistently enhance our value proposition to the customers and adhere to our promised standards of service delivery
- We will respect the universal declaration of human rights, International Labour Organization's fundamental conventions on core labour standards and operate as an equal opportunities employer
- We shall encourage and support our partners to adopt responsible business policies, Business Ethics and our Code of Conduct Standards
- We will continue to serve our communities:
 - By implementing sustainable Community Development Programmes including through public/private partnerships in and around our area of operations
 - By constantly protecting ecology, maintaining and renewing bio-diversity and wherever necessary conserving and protecting wild life, particularly endangered species
 - By encouraging our employees to serve communities by volunteering and by sharing their skills and expertise
 - By striving to deploy sustainable technologies and processes in all our operations and use scarce natural resources efficiently in our facilities
 - We will also help communities that are affected by natural calamities or untoward incidence, or that are physically challenged in line with the Tata Group's efforts

The management will commit all the necessary resources required to meet the goals of Corporate Sustainability.



(Praveer Sinha)
CEO & Managing Director

Date: 15th June, 2018

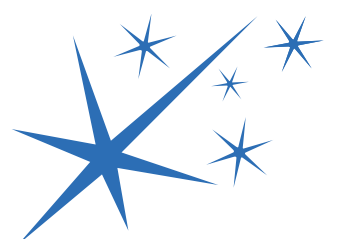

Supplier Code of Conduct

Tata Power follows the Tata Code of Conduct (TCoC) and the Whistle blower Policy and expect all its Suppliers to adhere to the same principles. “Supplier” here means any business, company, corporation, person or other entity that provides, sells or seeks to sell, any kind of goods or services to Tata Power, including the Supplier’s employees, agents and other representatives.

Tata Code of Conduct- (TCoC): <https://www.tatapower.com/pdf/aboutus/Tata-Code-of-Conduct.pdf>

Whistle Blower Policy: <https://www.tatapower.com/pdf/aboutus/whistle-blower-policy-and-vigil-mechanism.pdf>

Anti-Bribery & Anti-Corruption Policy: <https://www.tatapower.com/pdf/aboutus/abac-policy.pdf>

The suppliers are expected to adhere to the following Do’s and Don’ts:

Do’s

1. The Suppliers shall be committed to supplying products and services of high quality that meet all applicable standards and laws, including product packaging, labelling and after-sales service obligations.
2. Comply with all applicable laws and regulations, both in letter and in spirit, in all the territories in which it operates.
3. Strive to provide a safe, healthy and clean working environment for its employees.
4. Strive for environmental sustainability, particularly with regard to the emission of greenhouse gases, consumption of water and energy and the management of waste and hazardous materials.
5. The Supplier shall represent our company (including Tata brand) only with duly authorised written permission from our company.
6. Safeguard the confidentiality on the use of intellectual property, information and data of the Company.
7. Gifts and hospitality given or received should be modest in value and appropriate as per Company Policy.
8. The assets of Tata Power shall be employed primarily and judiciously for the purpose of conducting the business for which they are duly authorised.
9. All actual or potential conflicts due to financial or any other relationship with a Tata Power employee shall be disclosed.

Don’ts

1. The Supplier shall not make unfair or misleading statements about the products and services of competitors.
2. Children shall not be employed at workplaces.
3. Forced labour shall not be used in any form.
4. The Suppliers shall neither receive nor offer or make, directly or indirectly, any illegal payments, remunerations, gifts, donations or comparable benefits that are intended, or perceived, to obtain uncompetitive favours for the conduct of its business with Tata Power.

Reporting Violations

The Supplier shall notify the Company regarding any known or suspected improper behaviour of other suppliers or employees relating to its dealings with Tata Power, by email to: cecounsellor@tatapower.com. The same can also be raised through our 3rd party ethics helpline facility:

Toll-free Number	1800 267 4065
Email	tatapower@tip-offs.in
Website & Chatbot	www.tatapower.tip-offs.in
Postal address	Attn to: Mr. Puneet Arora, Deloitte Touch Tohmtsu India LLP, 6 floor, AIPL Business, Sector 62, Gurugram, Haryana 122102

The Tata Power Company Ltd	TPCODL		TPNODL	Appendix 3 to CSCC Safety Terms and Conditions
Document No. TPSMS/GSR/STC/009 REV 05	TPSODL	TATA TATA POWER	TPWODL	Date of Issue: 01/08/2023

Appendix 3:

Safety Terms and Conditions

Reason for Change	Date of Last Revision	Prepared By	Reviewed By	Approved by
Inclusion of Odisha Discom and periodic Revision	<u>10-Jan-2021-R4</u>	All Discom and CFT members	Debi Prasad Acharya (Head-Safety-Odisha Discom)	Suresh H Khetwani (Chief safety and Environment)

Clause	Sub-clause	Description	Page No
1.0		Objectives	3
2.0		Scope	3
3.0		Safety Organization & Responsibilities	3
	3.1	Contractor Site Management and Supervision	3
	3.2	Contractor Supervisors and General Staff	4
	3.3	Contractor Workforce	4
	3.4	Vendor/Contractor/sub-contractor	5
4.0		<u>Tools and Tackles(R5)</u>	6
5.0		Site Safety Rules and Procedures	6
6.0		Critical safety Rules and Procedures	6
7.0		<u>General Safety Rules and Procedure(R5)</u>	8
8.0		Training and Capability Building	10
9.0		Pre-Employment and Periodic Medical check-up	12
10.0		Safety performance retention(R5) and Safety Performance Evaluation	12
11.0		<u>Recognition to the Prior Learning in Safety-R5</u>	12
12.0		Other Conditions	13
<u>General Safety Conditions for various contracts Specific to Discom(R5)</u>			
13.0		<u>Safety Conditions for maintenance of STS (Sub Transmission System) Network for Discom(R5)</u>	14
14.0		<u>Safety Conditions for maintenance of 11 KV and LT Network for Discom(R5).</u>	15
15.0		<u>Safety Conditions for the major contract work in Civil Projects for Odisha Discom(R5)</u>	16
16.0		<u>Safety Conditions for the major contract work in Commercial Department like - MMG, RRG, EAG, etc(R5)</u>	17
17.0		<u>Safety Conditions for Major Projects in Distribution Network(R5)</u>	18
18.0		<u>Schedule of Safety Audits by BA Safety Staff(R5)</u>	19

The Tata Power Company Ltd	TPCODL	 TATA	TPNODL	Appendix 3 to CSCC Safety Terms and Conditions
Document No. TPSMS/GSR/STC/009 REV 05	TPSODL	 TATA POWER	TPWODL	Date of Issue: 01/08/2023

1.0 Objective:

The Objective of Safety Terms and Conditions is to apprise the Business Associates about various critical procedures of the Tata power Division/Discoms and the expectations from the BA to implement such procedures without fail. Certain terms and conditions are also mentioned to ensure a safe work atmosphere round the year. Refer Contractor's Safety Code of Conduct- Document no TPSMS/GSP/ CSM/015

2.0 Scope:

This procedure applies to all operating and project sites of The Tata Power Company Ltd and Group companies including new businesses like Electric Vehicle charging, Home Automation, Microgrid, Roof top solar etc. This Code of Conduct also applies to all operating and project sites of four Odisha Discoms and New business based on mutually agreed timeline for implementation. R5

3.0 Safety Organization & Responsibilities

3.1 Contractor Site Management and Supervision

Each Contractor will be responsible for fulfilling all statutory and safety requirements as per the laws of the land and not limited to Factory Act, Electricity Act, Electricity Rules and Regulations, Shop and Establishment Act etc.

Each Contractor shall provide at least one competent full-time safety supervisor for workforce of every 50 workers or less than that. When workforce ranges to 500, the contractor must provide at least one qualified safety officer (This may be subjected to change as per applicable act). Thus, for work force of 500 workers there will be one qualified safety officer and 10 safety supervisors. For every 500 additions in workforce, the contractor must add 1 safety officer and 10 safety supervisors. The Order Manager or Safety Department of the Tata Power Division /Discoms will review and approve the appointment of all safety officers and supervisors. The safety supervisors/officers will work with the guidance from Tata Power Division /Discoms Safety Department and align themselves with Tata power Division/Discom safety requirements.

For O&M related AMC activities, minimum one qualified safety officer to be deployed for each Division of the Discoms.

Qualified safety officer means he or she has completed PDIS or ADIS from a recognized institute.

Site Safety Officer/Safety Supervisor / Safety Coordinator shall be interviewed by the Order Manager/ Safety head of the Tata Power Division/Discom and then gate passes shall be issued if the interview is successful.

The Tata Power Company Ltd	 	 	 	Appendix 3 to CSCC Safety Terms and Conditions
Document No. TPSMS/GSR/STC/009 REV 05				Date of Issue: 01/08/2023

Site Manager of Contractor/Subcontractor is responsible, and will be held accountable, for the safety of their own workforce as well as that of sub-contractors. He should also ensure that all equipment, materials, tools, and procedures remain in safety compliance at job site.

Responsibility of Site manager includes, but not limited to:

- 3.1.1 Holding officer/supervisors accountable for safety and actively promote safe work performance.
- 3.1.2 Participate in and cooperate with all safety program requirements to be implemented to meet Tata Power Division /Discoms safety objectives
- 3.1.3 Ensure timely reporting of safety incidents, near misses, unsafe acts, and conditions.
- 3.1.4 Identify the training needs of BA employees and maintain all safety training documents.
- 3.1.5 Provide Safety Performance Report at an agreed frequency.
- 3.1.6 Stopping of unsafe work (Acts and/or Conditions) immediately. Work to start only after corrective actions are implemented.
- 3.1.7 Ensure and participate in daily toolbox talk for all the jobs.
- 3.1.8 Ensure that only tested and certified tools and equipment are issued to the workers and being used at the site.

3.2 Contractor Supervisors and General Staff.

Contractors' site supervisors and general staff members in charge of job site functions such as field engineering, warehousing, purchasing, costing, and scheduling etc. are responsible for the safe performance of the work of those they supervise. They must set an example for their fellow employees by being familiar with applicable sections of the Site Safety program and ensuring that all site activities are performed with SAFETY as the primary objective.

Each site supervisor is responsible and will be held accountable for identifying, analyzing, and eliminating or controlling all hazards through implementation of an aggressive, pro-active Health, Safety and Environmental Program. Each supervisor will proactively participate in the Safety program by observing, correcting, and recording unsafe acts and conditions at plant / sites.

3.3 Contractor Workforce

- 3.3.1 Contractors shall provide adequate quality and quantity of manpower as mutually agreed. (R5)
- 3.3.2 All the contractor employees shall attend "SHE L0(Other than new business and Odisha Discom)/L1 Foundation Course in Safety". Depending on the critical procedure in job employees shall also be required to attend "SHE L2 course of critical/high risk operations". All Supervisors shall be required to attend "SHE L3 Supervisory Training". All the above trainings will be conducted by TPSDI/Skill development institute of Disco, or other equivalent institute approved by Tata Power.

The Tata Power Company Ltd	TPCODL		TPNODL	Appendix 3 to CSCC Safety Terms and Conditions
Document No. TPSMS/GSR/STC/009 REV 05	TPSODL	TATA	TPWODL	Date of Issue: 01/08/2023
TATA POWER				

- 3.3.3 Contractor employees shall be required to attend any other additional training if suggested by Order manager or Site Safety Head. The cost of such additional training shall be borne by the Vendor.
- 3.3.4 Contractor / Vendor shall mobilize their manpower well in advance to complete the training through TPSDI/Sill development Institute.
- 3.3.5 The Vendor / BA shall arrange or bear the conveyance and food expenses incurred during training of BA employees in Odisha Discom. (R5)
- 3.3.6 The validity of the training L1, L2 and L3 is 3 years. There will be competency assessment as Revalidation test in every three months for Tata Power Division and six months for Odisha Discom till one year from implementation of CSCC.(R5) Those who fail in the competency assessment shall undergo training again.
- 3.3.7 Supervisors/Welder/Electricians/Line man /Fitters /Radiographers/Riggers engaged by the contractor shall have valid competency certificates issued by authorized agency/Institute.
- 3.3.8 Contractor workforce must make safety a part of their job by following safety rules and regulations and by using all safeguards and safety equipment. They must take an active part in the Safety programs for the Site.
- 3.3.9 Every member of the workforce is expected to report for work without influence of any Drug/Alcohol. Failure to comply with this requirement shall result in immediate termination of employees under the influence of drug and alcohol plus show cause notice/penalty to the vendor.
- 3.3.10 All employees shall report hazardous conditions, practices and behaviours in their work areas and correct wherever possible.
- 3.3.11 Workforce is responsible for active participation in safety and health programs, suggestion systems, trainings and reporting of unsafe act/practices, Unsafe conditions incidents and injuries to their supervisors.

3.4 Vendor/Contractor/sub-contractor

- 3.4.1 Vendors/Contractor shall always comply with and ensure that their workforce comply with all site safety rules and regulations. Specifically, with applicable provisions of the Site Safety Management Plan and all statutory safety rules and regulations.
- 3.4.2 After receiving the work order/ purchase order vendor/contractor/bidder shall not appoint Sub-contractor without safety assessment of the sub-contractor through safety concurrence group Under Contractor Safety Code of Conduct. Penalty of 5% of contract value will be applicable to the contractor if subcontractor is appointed without the permission of SCG and without evaluation through CSCC process.

The Tata Power Company Ltd	 	 	 	Appendix 3 to CSCC Safety Terms and Conditions
Document No. TPSMS/GSR/STC/009 REV 05				Date of Issue: 01/08/2023

4.0 Tools and Tackles(R5)

- 4.1 Tools & Tackles used to carry out the job shall be checked and inspected by Order Manager and safety Officer.
- 4.2 Vendor must submit a valid Certificate from Competent person under the Factories Act 1948 and State Factories Rule for all Lifting Tools and Tackles (like Hoist, D Shackles, chain Block, wire ropes etc.).
- 4.3 All Electrical Hand Tools must be tested for leakage of current by a person /agency authorized by Tata Power Division /Discoms. Electrical power must be taken though RCCB of 30mA. Electrical hand tools should not have cord more than 3 meters in length. If power source is at > 3 meters, extension boards with RCCB of 30 mA and ON/OFF switch, shall be used.
- 4.4 Removal or inclusion of tools any new tool /tackles / machinery / equipment at site should only be done with concurrence of the order Manager / Head Safety.

5.0 Site Safety Rules and Procedures:

The work in the safest possible manner can only happen when it has been carefully planned and all applicable procedures are followed. The Tata Power Safety Procedures are derived from Tata Power best practices and the applicable Government acts regulations. In each case, the most stringent regulation is used. All safety rules and procedures developed from time to time shall be mandatorily followed by the vendor and his employees while working at Site.

6.0 Critical safety Rules and Procedures: Following is the list of Tata Power's critical Safety Rules and Procedures. Contractor shall refer to approved Rules and Procedures for detailed requirements and ensure conformance

6.1 Lock Out and Tag Out Procedure.

This procedure is intended to be used for the protection of Personnel while servicing or performing maintenance on distribution network/ equipment / pipeline / vessel / process systems. This is a general procedure that shall be used as the minimum requirements for isolation of equipment, pipelines, machines, system from all possible sources of hazardous energy and / or material such as Steam, Hot Water, Compressed Air, any other process fluid / chemical energy /Mechanical energy or Electrical energy. For complete procedure kindly refer Procedure Document No. **TPSMS/CSP/LOTO/001**

6.2 Excavation Safety (Shoring and Sloping) Procedure

This procedure is developed to cover the safe practices required for shoring and sloping in excavation and trenching jobs. This procedure is developed to establish mandatory requirements for practices to protect personnel, property and equipment from hazards associated with above activities. For complete procedure kindly refer Procedure Document No **TPSMS/CSP/EXS/002**

6.3 Confined Space Entry Procedure:

This procedure outlines the steps required to perform the confined space entry and to protect personnel from the hazards of entering and conducting operations in confined spaces. For complete procedure kindly refer Procedure Document No – **TPSMS/CSP/CSE/003**.

The Tata Power Company Ltd	 	 	 	Appendix 3 to CSCC Safety Terms and Conditions
Document No. TPSMS/GSR/STC/009 REV 05				Date of Issue: 01/08/2023

6.4 Working at Height Procedure:

This procedure describes the rules and procedures to protect employees from the hazards of working at heights. This procedure is developed to cover the safe practices required for Working at Heights. This procedure is developed to establish mandatory requirements for practices to protect personnel from hazards associated in this area. For complete procedure kindly refer Procedure Document No – TPSMS/CSP/WAH/004.

6.5 Heavy Equipment Movement Safety Procedure.

Heavy equipment lifting and movement is an activity involving loading, unloading, storage and movement from one place to another including lifting and erection or repairing of equipment with cranes or hoists. Material, machinery and equipment handling operations are being carried out by large capacity cranes and hoists, which make the job safer and faster. This procedure addresses the hazards and precautions associated with such equipment and their use. For complete procedure kindly refer Procedure Document No – TPSMS/CSP/HEMS/005.

6.6 Mobile Crane Safety Procedure.

Mobile cranes are responsible for many incidents, injuries. Falling loads from mobile cranes pose a severe hazard to operators and nearby workers and property. Many types of cranes, hoists, and rigging devices are used for lifting and moving materials. To maintain safe, appropriate standards must be adhered to and only qualified and licensed individuals shall operate these devices. For complete procedure kindly refer Procedure Document No – TPSMS/CSP/MCS/006.

6.7 Scaffold Safety Procedure.

This procedure is developed to provide information on the safe erection, use, dismantling and maintenance of access scaffolding in the workplace. It is developed to establish mandatory requirements for practices to protect personnel from hazards associated with erection, use and dismantling of scaffolds. For complete procedure kindly refer Procedure Document No – TPSMS/CSP/SCAF/007.

6.8 Permit to Work Procedure.

Given the inherent hazards of the power generation and distribution industry, a significant number of TATA POWER operations and installations are critical. Work Permit (WP) System is an essential element in controlling the workplace risks in an effective manner. For complete procedure kindly refer Procedure Document No – TPSMS/CSP/PTW/008.

6.9 Job Safety Analysis (JSA) Procedure.

This objective of this procedure is to have a task-based risk assessment process in place that identifies, evaluates and controls the risks associated with work activities, and as a result, prevents those involved in the task or those potentially affected by the task, from being harmed. For complete procedure kindly refer Procedure Document No- TPSMS/CSP/JSA/009 REV 01.

6.10 Electrical Safety Procedure.

The Tata Power Company Ltd				Appendix 3 to CSCC Safety Terms and Conditions
Document No. TPSMS/GSR/STC/009 REV 05				Date of Issue: 01/08/2023

The objective of these standards is to specify minimum mandatory requirements and advisory guidance for identifying and controlling hazards to ensure 'Zero Harm' regarding operation maintenance and testing of electrical equipment. For complete procedure kindly refer Procedure Document No- TPSMS/CSP/ELEC/010

6.11 Fire Safety Management Procedure.

Objective of This standard is to specify the minimum mandatory requirements and advisory guidelines to ensure prevention of fire related incidents and managing / controlling their impacts if they do occur. For complete procedure kindly refer Procedure Document No - TPSMS/CSP/ELEC/011

6.12 Hazard Identification & Risk Assessment (HIRA) Procedure(R5):

Objective of this procedure is to define guidelines for Hazard identification, Risk assessment and determination of controls. For complete procedure kindly refer Procedure Document No - TPSMS/CSP/HIRA/012.

6.13 Management Of Change (MOC) Procedure(R5):

The objective of this document is to establish the procedures necessary to ensure that HSE risks are managed to an acceptable level in Tata Power Management of Change (MOC) process. For complete procedure kindly refer Procedure Document No - TPSMS/CSP/MOC/013.

6.14 Pre-Start-up Safety Review (PSSR) Procedure(R5).

Objective of this procedure is to provide guidelines for safe initial startup of a new facility or restart of a modified facility. The PSSR process verifies that the new/modified facility meets the original design and operating parameters. The intent is to prevent incidents caused by inadequate, incomplete, unauthorized design, construction, installation, and/or commissioning. For complete procedure kindly refer Procedure Document No - TPSMS/CSP/MOC/014.

6.15 Road Safety procedure(R5):

To provide Safety Rules for road travel management and safe usage of all types of vehicles viz. passenger/ commercial, owned/ hired by company, driven by employees or contractors. For complete procedure kindly refer Procedure Document No - TPSMS/CSP/RSP/015.

7.0 General safety Rules and Procedure:

7.1 Lift (Elevator) Safety Procedure:

To provide safe operating procedure for taking control of lift car before entering and existing the pit of OTIS make elevators. For complete procedure kindly refer Procedure Document No – TPSMS/GSP/LIFT/001,

7.2 Working on conveyor belt Procedure:

This procedure is developed to cover the safe practices required for Working on live equipment and to protect personnel from hazards associated with it. For complete procedure kindly refer Procedure Document No – TPSMS/GSP/CONV/003

7.3 Batteries Handling & Disposal(R5)

The Tata Power Company Ltd	 	 	Appendix 3 to CSCC Safety Terms and Conditions
Document No. TPSMS/GSR/STC/009 REV 05			Date of Issue: 01/08/2023

To provide procedure for recycling and / or safe disposal of used / waste batteries in compliance with all legislation. For complete procedure kindly refer Procedure Document No – **TPSMS/GSP/HAZM/003**

7.4 Material Handling and Storage Procedure:

The purpose of this document is to provide procedures to assist the safe handling of materials (manual handling and mechanical handling). For complete procedure kindly refer Procedure Document No – **TPSMS/GSP/MATL/004**.

7.5 Office Safety Procedure(R5):

The objective is to provide a safe working environment to those working in office premise, who may be exposed to emergency situations and other chronic / cumulative risks that may arise due to various reasons of unsafe act, unsafe condition, fire and or pandemic crisis like COVID-19 etc. For complete procedure kindly refer Procedure Document No - **TPSMS/GSP/OFS/006**

7.6 Earth Leakage Circuit Breaker (ELCB) Testing Procedure(R5):

The objective of this procedure is to define the minimum requirements for testing of Earth Leakage Circuit Breaker (ELCB). For complete procedure kindly refer Procedure Document No - **TPSMS/GSP/ELCB/008**.

7.7 Occupational Health & Safety Legal Compliance Procedure(R5):

Objective of this procedure is provide guidelines for compliance of Occupational Health & Safety (OH&S) legal requirements and all ratified protocols and agreements are incorporated in Tata Power Safety Management System (SMS). For complete procedure kindly refer Procedure Document No - **TPSMS/GSP/LEGL/009**.

7.8 Incident Reporting & Investigation Procedure(R5):

Objective of this procedure is to outline the process for reporting, recording and investigating an incident, recommending corrective and preventive actions and to communicate the lessons learned to prevent recurrence of similar incidents. For complete procedure kindly refer Procedure Document No - **TPSMS/GSP/IRI/011**.

7.9 Contractor Safety Management Procedure.

The purpose of this document is to engage with contractors in a way to create safe work environment for everyone working for Tata Power. For complete procedure kindly refer Procedure Document No – **TPSMS/GSP/CSM/015**.

7.10 Tree Trimming Procedure(R5):

The objective of this procedure is to define guidelines and minimum requirements for Tree trimming. For complete procedure kindly refer Procedure Document No – **TPSMS/GSP/TTRM/017**

7.11 Safe Lone Working Procedure(R5):

Objective of this procedure is to lay down guidelines for reduction and safe managing of any additional risk arising from lone working. For complete procedure kindly refer Procedure Document No – **TPSMS/GSP/LONE/019**.

7.12 Good Housekeeping(5S) Procedure(R5):

The Tata Power Company Ltd	 	 	 	Appendix 3 to CSCC Safety Terms and Conditions
Document No. TPSMS/GSR/STC/009 REV 05				Date of Issue: 01/08/2023

Objective of this procedure is to explain the meaning, importance and provide guidelines for implementation of Good Housekeeping(5S) at workplaces across organization. For complete procedure kindly refer Procedure Document No – **TPSMS/GSP/GHK/022**.

7.13 Personal Protective Equipment(R5):

This procedure describes the basic requirements, applicability, minimum specifications of Personal Protective Equipment (PPE). For complete procedure kindly refer Procedure Document No – **TPSMS/GSP/PPE/023**.

7.14 Process Safety Management Procedure(R5):

The objective of this document is to provide a standardized & uniform guideline to implement Process Safety Management in Tata Power, its JVs, and subsidiaries to prevent or minimize the consequences of releases of toxic, flammable, pressurized or uncontrolled chemicals/Steam/Water or any other material which may result in toxic, fire, explosion, burn or flood like situation. For complete procedure kindly refer Procedure Document No – **TPSMS/GSP/PSM/024**

The above procedures will be updated time to time and the updated version of the procedures as well as any additional critical procedure will be available on official website of Tata Power (www.tatapower.com) for your reference.

8.0 Training and Capability Building.

Safety Training and capability building of workforce is a major component of safety management program. All training required must be provided and documented as specified by Tata Power and Indian Regulations. Tata Power Division /Discoms Safety department will audit contractors training and related documentation to assure its adequacy.

8.1 Tata power Odisha Discom Site Safety Orientation.R5

All Tata Power contractor and subcontractor workforce is required to attend Site Safety Orientation Training to receive a Safety Training Card, which is required to obtain a Gate Pass to the site, prior to entry. This Safety Orientation Course will be for duration of minimum half day. The information provided during the orientation will include, but is not limited to following:

- 8.1.1 Job rules, personal safety, and conduct
- 8.1.2 Hazard's reporting
- 8.1.3 Reporting of injuries
- 8.1.4 Emergency procedures
- 8.1.5 Safety Activities and Program including disciplinary measure and incentives.
- 8.1.6 Critical safety procedure relevant to the job

8.2 Capability Building:

- 8.2.1 All Tata Power contractor and subcontractor workforce is required to attend L1 Training to receive a Safety Training Card, which is required to obtain a Gate Pass to the site, prior to entry.
- 8.2.2 Appropriate practical training such as SHE L1, L2& L3 is given to ensure that a jobholder, either supervisor or worker, is competent to do his/her job safely. The skill training is provided through TPSDI, and other agencies authorized

The Tata Power Company Ltd				Appendix 3 to CSCC Safety Terms and Conditions
Document No. TPSMS/GSR/STC/009 REV 05				Date of Issue: 01/08/2023

by Tata Power on the list of 15 critical Safety procedures mentioned under safety procedures. Duration of course is as specified by Division/Discom

- 8.2.3** Contractor shall ensure that concerned workmen are provided with adequate training before he/she is allowed to execute the work. An evaluation test will be conducted after the completion of the training. Those employees who meet the minimum required competency will be provided with Certificate (Card), which will be valid for 3 years, post which the workmen have to reappear for assessment.
- 8.2.4** If the workman is not able to qualify the assessment, he/she will be given 3 additional attempts to clear in 3-month time failing which he/she will not be allowed to work in the Division /Discoms.
- 8.2.5** After expiry of Certificate or Training /Competency Card again one day recertification of L1, L2 and L3 skill training will be provided. R7.
- 8.2.6** Quarterly /Half yearly(For Odisha and New business) Revalidation Test - "SHE L1 Revalidation test" will be conducted for the contractor's employees to revalidate their safety awareness and knowledge.
- 8.2.7** Order Manager and Safety In charge of the Division/Site /Plant will conduct a Competency Assessment of all workforces, going to be deployed at site / plant for high-Risk job.
- 8.2.8** The Contactor shall bear the conveyance and food expenses of his staff for attending training sessions and capability building sessions in new business-like Odisha Discom.
- 8.2.9** The Contactor shall bear the entire cost of L1/L2/L3, the costs towards training, salaries/wages, boarding and lodging of his staff for attending training sessions and capability building sessions. These trainings are offered on nominal chargeable basis payable by Contractor and rates shall be decided by TPSDI from time to time in case of training through TPSDI. Generally, L0 is of one day, L1 is for 2 days for each critical procedure and L3 is for one day. Around Rs 700+GST is approx. cost /Day/Candidate. -R5
- 8.2.10** Competency assessment of all critical workforce to be carried out for all who has taken L2 training. R5

9.0 Recognition to the Prior Learning in Safety-R5

If "Order Manager" recommends and "Head of the Safety Department of Discom" is satisfied with the safety knowledge and competency of the employee of contractor, a test may be conducted by Tata power Skill development Institute/ other recognized institute to assess the prior learning in safety. If employees of the contractors pass in such test, he will be exempted from appearing in SHE L1 training. This assessment is on nominal chargeable basis and rates are decided by TPSDI from time to time.

10.0 Safety performance retention(R5) and Safety Performance Evaluation: A certain percentage of the bill value will be retained against every running bill as safety performance retention. The amount will be released with the last invoice or every six-month based on Safety Performance Score of contractors. This is as per CSCC Document no TPSMS/GSP/ CSM/015

The Tata Power Company Ltd	 	 	 	Appendix 3 to CSCC Safety Terms and Conditions
Document No. TPSMS/GSR/STC/009 REV 05				Date of Issue: 01/08/2023

This safety retention shall be waived for Contractors who have either submitted a Contract Performance Bank Guarantee or have a retention from each running bill for an amount not less than 10% of each bill subject to the express undertaking / understanding that if there are any deductions required to be made for safety non-performance as per the Safety Performance Score, then Tata Power shall recover any such deductions against safety non-performance directly from the monthly bills / final settlement as the case may be failing which it shall be within its right to recover such sum from accounts payable or the CPBG or the retention of the Contractor available with Tata Power for the said contract or any other contract between the Contractor and Tata Power.

11.0 Pre-Employment and Periodic Medical check-up:

Contractor shall arrange to conduct a pre-employment and periodic medical check-up for its entire workforce by Tata Power medical officer or Tata Power authorized medical officer. The contractor shall be able to produce the certificate prior to the employment. The contractor shall also organize to conduct periodical medical checkup (six monthly) for the following category of employees:

- Drivers (Check for Vision & Hearing)
- HEM Equipment Operators (Check for Vision & Hearing)
- Workforce working at Height (Check for Vision, Hearing, Vertigo & Height Phobia)
- Workforce Handling the hazardous substances - Coal, ash and chemicals (Chest X-ray and Lung Function T)
- Workforce in high Noise area (> 90 Decibel), Check for Hearing
- Workforce handling radiography equipment for conducting NDT.
- Workforce, working in specific areas requiring specific medical attention should conduct the medical tests test as laid down in the respective Site Safety Management Plan.

12.0 Other Conditions:

- 12.1. The manpower/vehicles/Tools & Tackles/Equipment provided shall be as per mutually agreed SLA.
- 12.2. No Supervision No work policy should strictly be followed.
- 12.3. Test Before Touch must be ensured every time a job is being carried out in electrical network.
- 12.4. HIRA /JSA as per the job scope must be prepared in detail and submitted along with Site Safety Plan by the successful bidder.
- 12.5. Personal protective equipment (PPE) must always be checked before use to ensure that they are in good condition and clean. Replace them if necessary.
- 12.6. All relevant PPE shall be provided by the vendor while working at the site.
- 12.7. Housekeeping shall be maintained all the time while execution of work. All the unwanted material shall be removed from the site at the end of the day's work. Old/damaged parts if taken out of the system shall be kept at

The Tata Power Company Ltd	TPCODL	 TATA	TPNODL	Appendix 3 to CSCC Safety Terms and Conditions
Document No. TPSMS/GSR/STC/009 REV 05	TPSODL	TATA POWER	TPWODL	Date of Issue: 01/08/2023

identified placed and it shall be shifted to scrap yard or disposed of as per instruction of order manager.

- 12.8. Site Safety Plan shall be prepared by successful bidder along with order manger. Appendix 1 to be filled by successful bidder and submitted to Tata Power safety in-charge, before mobilization of team at site and start of the work.
- 12.9. The Owner or Proprietor of BA must visit worksite at least once in a month and meet Order Manager every month. In case of incidents, the Owner or Proprietor of BA is required to attend Time Out Meetings to understand the gaps that contributed to the incident.

CONFIDENTIAL

The Tata Power Company Ltd				Appendix 3 to CSCC Safety Terms and Conditions
Document No. TPSMS/GSR/STC/009 REV 05				Date of Issue: 01/08/2023

General Safety Conditions for various contracts Specific to Odisha Discom(R5)

13.0. Safety Conditions for maintenance of STS (Sub Transmission System) Network.

A BA awarded a major contract work of maintenance of sub – transmission network in area of a power system will be required to fulfil the following conditions:

- Availability of Discharge Rods - Minimum 6 Nos. in each maintenance vehicle, fit for purpose and in good conditions and defective rods are removed from service.
- Availability of Neon tester - Minimum one Neon Tester in each Maintenance Vehicle, in good and working condition and defective or non-standard neon testers are removed from service.
- Electrical hand Gloves - Minimum two sets of 33 KV and two sets of 11 KV in maintenance vehicles.
- The BA linemen must be having required ELBO certification for the voltage level involved.
- BA shall provide Safety Policy, Safety Objectives, Organogram showing structure and responsibility of Safety management of his company and shall document the work practices and procedures in terms of Safety Management.
- BA shall comply with all statutory requirements like applicable acts, regulations, codes of practice, OHSAS Standards, Labour laws, etc.
- The BA shall participate in Safety promotional activities like celebration of Lineman day on 4th March, National Fire Service Day on 14th April and Theme based safety campaigns undertaken by the Discoms every month.
- BA shall abide by Safety manuals and guidelines of Discom issued from time to time.
- BA shall ensure safety training and induction program for the employees. The BA employees must carry safety training card / competency card to the worksite and produce the card on demand.
- All BA employees must be given valid ID card issued by BA cell of Discom who will check statutory compliances before issuing ID cards.
- BA shall not employ a new workman without training and issue of ID card.
- BA shall conduct safety audits & inspections as per Discom procedures.
- BA shall provide proper PPEs as per CSM F-8 ensure periodic inspection of PPE, Tools and tackles to ensure their serviceability.
- BA shall ensure the adherence to standard operating procedures or guidelines laid down by the Discoms.
- BA shall ensure that no job shall be carried out without efficient supervision.
- BA shall ensure reporting of any unsafe act, unsafe conditions, near miss, incident, or accident to engineer in-charge and SAFETY team of the Discom.
- BA shall provide safety performance and Safety MIS to engineer in-charge and Discom SAFETY group periodically. Based on any non-confirmation to the safety procedures and guidelines, BA is liable to be negatively marked for his performance and suitable penalty will be imposed.
- BA safety staff shall work as per the guidance of the Discom safety department and functionally report Safety Head of Discom. Any leaves by safety staff of the BA shall have to approved by Discom Safety Department.
- BA shall ensure to depute Safety Staff for managing safety in worksites. In case the BA has been awarded work in more than one area power system, then the following safety structure will be adopted.
- Safety manager and Safety engineer must be having PDIS or ADIS.

The Tata Power Company Ltd	 	 	 	Appendix 3 to CSCC Safety Terms and Conditions
Document No. TPSMS/GSR/STC/009 REV 05				Date of Issue: 01/08/2023



14.0 Safety Conditions for maintenance of 11 KV and LT Network.

A BA awarded a major contract work of maintenance of 11 KV and LT Network in area of a power system will be required to fulfil the following conditions:

- Availability of Discharge Rods - Minimum 6 Nos. in each PSS/FCC and maintenance vehicle, fit for purpose and in good conditions and defective rods are removed from service.
- Availability of Neon tester - Minimum one Neon Tester in each PSS/FCC/ Maintenance Vehicle, in good and working condition and defective or non-standard neon testers are removed from service.
- Electrical hand Gloves - Minimum two sets of 33 KV and two sets of 11 KV in each PSS/Maintenance vehicles and two sets of LT hand gloves at each FCC.
- The BA linemen must be having required ELBO certification for the voltage level involved.
- BA shall provide Safety Policy, Safety Objectives, Organogram showing structure and responsibility of Safety management of his company and shall document the work practices and procedures in terms of Safety Management.
- BA shall comply with all statutory requirements like applicable acts, regulations, codes of practice, OHSAS Standards, Labour laws, etc.
- BA shall abide by Safety manuals and guidelines of Discom issued from time to time.
- BA shall ensure safety training and induction program for the employees. The BA employees must carry safety training card / competency card to the worksite and produce the card on demand.
- All BA employees must be given valid ID card issued by BA cell of Discom who will check statutory compliances before issuing ID cards.
- BA shall not engage new workman without training and issue of ID card.
- PSS operator shall not be involved in maintenance activities.
- BA shall conduct safety audits & inspections as per Discom procedures.
- BA shall provide proper PPEs as per CSM F-8 ensure periodic inspection of PPE, Tools and tackles to ensure their serviceability.
- The BA shall participate in Safety promotional activities like celebration of Lineman day on 4th March, National Fire Service Day on 14th April and Theme based safety campaigns undertaken by the Discoms every month.
- BA to ensure that all LT complaints are routed through Call Centre and recorded in FCC. Rectification of fault shall be done only after call centre logging and with the knowledge of BA supervisor.
- No one will work alone or unsafely under public pressure or otherwise.
- BA shall ensure the adherence to standard operating procedures or guidelines laid down by the Discoms.
- BA shall ensure that no job shall be carried out without efficient supervision.

The Tata Power Company Ltd	 	 	 	Appendix 3 to CSCC Safety Terms and Conditions
Document No. TPSMS/GSR/STC/009 REV 05				Date of Issue: 01/08/2023

- BA shall ensure reporting of any unsafe act, unsafe conditions, near miss, incident, or accident to engineer in-charge and SAFETY team of the Discom.
- BA shall provide safety performance and Safety MIS to engineer in-charge and Discom SAFETY group periodically. Based on any non-confirmation to the safety procedures and guidelines, BA is liable to be negatively marked for his performance and suitable penalty will be imposed.
- BA safety staff shall work as per the guidance of the Discom safety department and functionally report Safety Head of Discom. Any leaves by safety staff of the BA shall have to approved by Discom Safety Department.
- BA shall ensure to depute Safety Staff - One safety supervisor per section, One safety engineer per sub-division and one safety manager per Division Safety manager and Safety engineer must be having PDIS or ADIS.

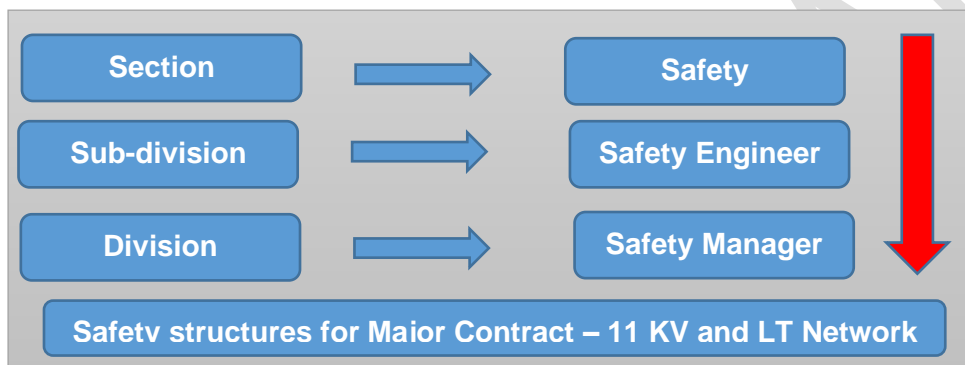

15.0 Safety Conditions for the major contract work in Civil Projects:

A BA awarded a major contract work of / in civil project will be required to fulfil the following safety conditions:

- BA shall provide Safety Policy, Safety Objectives, Organogram showing structure and responsibility of Safety management of his company and shall document the work practices and procedures in terms of Safety Management.
- BA shall comply with all statutory requirements like applicable acts, regulations, codes of practice, OHSAS Standards, Labour laws, etc.
- BA shall abide by Safety manuals and guidelines of Discom issued from time to time.
- BA shall ensure safety training and induction program for the employees. The BA employees must carry safety training card / competency card to the worksite and produce the card on demand.
- All BA employees must be given valid ID card issued by BA cell of Discom who will check statutory compliances before issuing ID cards.
- BA shall not employ a new workman without training and issue of ID card.
- BA shall conduct safety audits & inspections as per Discom procedures.
- BA shall provide proper PPEs as per CSM F-8 ensure periodic inspection of PPE, Tools and tackles to ensure their serviceability.
- BA shall ensure the adherence to standard operating procedures or guidelines laid down by the Discoms.
- BA shall ensure that no job shall be carried out without efficient supervision.
- BA shall ensure reporting of any unsafe act, unsafe conditions, near miss, incident, or accident to engineer in-charge and SAFETY team of the Discom.

The Tata Power Company Ltd		Appendix 3 to CSCC Safety Terms and Conditions
Document No. TPSMS/GSR/STC/009 REV 05		Date of Issue: 01/08/2023

- The BA shall participate in Safety promotional activities like celebration of Lineman day on 4th March, National Fire Service Day on 14th April and Theme based safety campaigns undertaken by the Discoms every month.
- BA shall provide safety performance and Safety MIS to engineer in-charge and Discom SAFETY group periodically. Based on any non-confirmation to the safety procedures and guidelines, BA is liable to be negatively marked for his performance and suitable penalty will be imposed.
- BA safety staff shall work as per the guidance of the Discom safety department and functionally report Safety Head of Discom. Any leaves by safety staff of the BA shall have to approved by Discom Safety Department.
- BA shall refer Construction Safety Manual of the Discom for details.
- BA shall ensure to depute a Safety Supervisor (for workforce up to 100 at site) / a safety engineer (for workforce up to 250 at site) / safety manager (for more than two safety engineers) for managing safety at the project site. In case the BA has been awarded more than one major contracts, then the following safety structure will be adopted.
- Safety Engineers and Safety Managers must be having PDIS or ADIS.



16.0 Safety Conditions for the major contract work in Commercial Department like - MMG, RRG, EAG, etc.:

A BA awarded a major contract work in meter management group & energy auditing group will be required to fulfil the following safety conditions:

- BA shall provide Safety Policy, Safety Objectives, Organogram showing structure and responsibility of Safety management of his company and shall document the work practices and procedures in terms of Safety Management.
- BA shall comply with all statutory requirements like applicable acts, regulations, codes of practice, OHSAS Standards, Labour laws, etc.
- BA shall abide by Safety manuals and guidelines of Discom issued from time to time.
- BA shall ensure safety training and induction program for the employees. The BA employees must carry safety training card / competency card to the worksite and produce the card on demand.
- All BA employees must be given valid ID card issued by BA cell of Discom who will check statutory compliances before issuing ID cards.
- BA shall not employ a new workman without training and issue of ID card.
- BA shall conduct safety audits & inspections as per Discom procedures.
- The BA shall participate in Safety promotional activities like celebration of Lineman day on 4th March, National Fire Service Day on 14th April and Theme based safety campaigns undertaken by the Discoms every month.
- BA shall provide proper PPEs as per CSM F-8 ensure periodic inspection of PPE, Tools and tackles to ensure their serviceability.

The Tata Power Company Ltd	TPCODL		TPNODL	Appendix 3 to CSCC Safety Terms and Conditions
Document No. TPSMS/GSR/STC/009 REV 05	TPSODL		TPWODL	Date of Issue: 01/08/2023

- BA shall ensure the adherence to standard operating procedures or guidelines laid down by the Discoms.
- BA shall ensure that no job shall be carried out without efficient supervision.
- BA shall ensure reporting of any unsafe act, unsafe conditions, near miss, incident, or accident to engineer in-charge and SAFETY team of the Discom.
- BA shall provide safety performance and Safety MIS to engineer in-charge and Discom SAFETY group periodically. Based on any non-confirmation to the safety procedures and guidelines, BA is liable to be negatively marked for his performance and suitable penalty will be imposed.
- BA safety staff shall work as per the guidance of the Discom safety department and functionally report Safety Head of Discom. Any leaves by safety staff of the BA shall have to be approved by Discom Safety Department.
- BA shall ensure to depute a Safety Supervisor for managing safety at worksite.
- The BA for the RRG work shall depute one Safety supervisor.

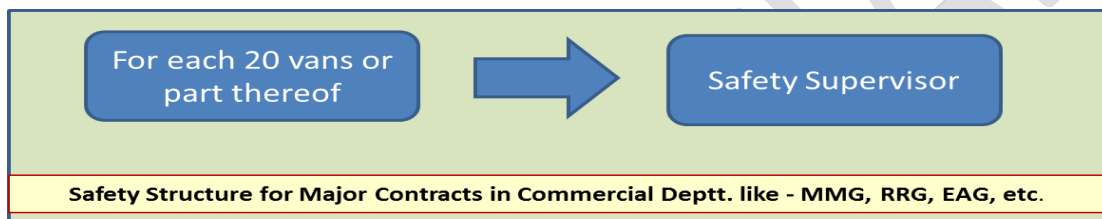

17.0 Safety Conditions for Major Projects in Distribution Network

A BA awarded a major Projects in Distribution Network shall be required to fulfil the following conditions:

- Availability of Discharge Rods - Minimum 6 Nos. for each project site, fit for purpose and in good conditions and defective rods are removed from service.
- Availability of Neon tester - Minimum one Neon Tester in each project site, in good and working condition and defective or non-standard neon testers are removed from service.
- Electrical hand Gloves - Minimum one sets of 33 KV, 11 KV and LT in each project site.
- The BA linemen must be having required ELBO certification for the voltage level involved.
- BA shall provide Safety Policy, Safety Objectives, Organogram showing structure and responsibility of Safety management of his company and shall document the work practices and procedures in terms of Safety Management.
- BA shall comply with all statutory requirements like applicable acts, regulations, codes of practice, OHSAS Standards, Labour laws, etc.
- BA shall abide by Safety manuals and guidelines of Discom issued from time to time.
- BA shall ensure safety training and induction program for the employees. The BA employees must carry safety training card / competency card to the worksite and produce the card on demand.
- The BA shall participate in Safety promotional activities like celebration of Lineman day on 4th March, National Fire Service Day on 14th April and Theme based safety campaigns undertaken by the Discoms every month.
- All BA employees must be given valid ID card issued by BA cell of Discom who will check statutory compliances before issuing ID cards.
- BA shall not employ a new workman without training and issue of ID card.
- BA shall conduct safety audits & inspections as per Discom procedures.
- BA shall provide proper PPEs as per CSM F-8 ensure periodic inspection of PPE, Tools and tackles to ensure their serviceability.

- BA shall ensure the adherence to standard operating procedures or guidelines laid down by the Discoms.
- BA shall ensure that no job shall be carried out without efficient supervision.

Sr. No	Type of Audit	Frequency
1	Tool Bag and PPE audit	Weekly
2	First Aid Box Maintenance Record	Fortnightly
3	Fire Extinguisher Record (Applicable for the BA involved in major construction works and have storage of flammable material at worksite)	Monthly
4	Safety Talk Register	Weekly
5	Site Safety Audit	Daily

- BA shall ensure reporting of any unsafe act, unsafe conditions, near miss, incident, or accident to engineer in-charge and SAFETY team of the Discom.
- BA shall provide safety performance and Safety MIS to engineer in-charge and Discom SAFETY group periodically. Based on any non-confirmation to the safety procedures and guidelines, BA is liable to be negatively marked for his performance and suitable penalty will be imposed.
- The BA shall participate in Safety promotional activities like celebration of Lineman day on 4th March, National Fire Service Day on 14th April and Theme based safety campaigns undertaken by the Discoms every month.
- BA safety staff shall work as per the guidance of the Discom safety department and functionally report Safety Head of Discom. Any leaves by safety staff of the BA shall have to approved by Discom Safety Department.
- BA shall ensure to depute Safety Staff for managing safety in worksites. One safety supervisor per project site or 100 persons, one safety engineer for 2 project sites of 250 persons, and one safety manager for four project sites or 500 persons.
- Safety manager and Safety engineer must be having PDIS or ADIS.

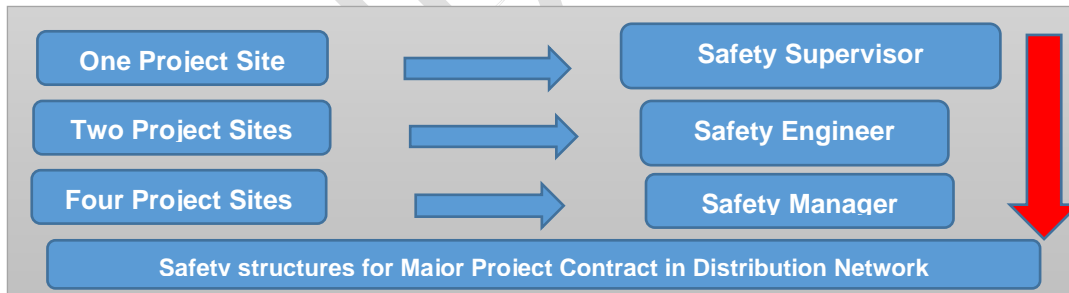

18.0 Schedule of Safety Audits by BA Safety Staff

Safety Undertaking of BA by way of Affidavit

I _____ s/o _____ R/o _____ (AUTHORIZED REPRESENTATIVE/PARTNER/DIRECTOR/PROPRIETOR) of M/S _____ (name of company/firm) having its office at (Complete address of Company), authorized vide power

The Tata Power Company Ltd	TPCODL		TPNODL	Appendix 3 to CSCC Safety Terms and Conditions
Document No. TPSMS/GSR/STC/009 REV 05	TPSODL	TATA	TPWODL	Date of Issue: 01/08/2023
TATA POWER				

of attorney dated -----/Board resolution dated----/letter of authority dated----, hereinafter referred to as **Contractor [or Business Associate (BA)]** which expression shall, unless it be repugnant to or inconsistent with the meaning or context thereof, be deemed to include its heirs, executors, administrators, and assigns do hereby affirm and undertake as under :

1. The present undertaking shall remain in force from the date of execution of contract and shall be valid till the date of termination of the said contract by either party. The undertaking is binding on me (contractor) as well as my sub-contractor and its employees, representatives etc.
2. That I (the contractor) will be responsible and liable to comply and abide by all the safety rules, instructions and regulations as may be specified and laid down by the Discom to achieve its goal of Zero for on-site incidences.
3. That the Contractor shall be fully responsible for ensuring occupational health and safety of its employees, representatives, agents as well as of its subcontractor's employees, at all times during the discharge of their respective obligations under the contract including any methods adopted for performance of their tasks / work.
4. That Contractor shall ensure ,at its own expense to arrange for and procure, implement all requisite accident prevention tools, first aid boxes, personal protective equipment, fire extinguisher, safety training, Material Safety Data Sheet, pre-employment medical test, etc. for operations & activities including as & when so specified by Discom specifically. , failing which Discom shall be entitled, but not obliged, to provide the same and recover the actual cost thereof from the Contractor's payments.
5. That the Contractor shall engage adequate and competent Safety – Supervisor / Engineer / Manager / Skilled persons at site as per the Para 5 (Qualification and experience of safety personnel) and Annexure 3 of Contract Safety Management.
6. That the Contractor shall engage the competent Site – Supervisor with each group of workers for safe and correct workmanship, proper co-ordination of material and site work as per contract.
7. That the Contractor shall immediately replace supervisor in case it is found to be not up to the level of skill and experience required, but any such replacement shall be only with the prior concurrence of the Discom representative.

The Tata Power Company Ltd	TPCODL	 TATA	TPNODL	Appendix 3 to CSCC Safety Terms and Conditions
Document No. TPSMS/GSR/STC/009 REV 05	TPSODL	 TATA POWER	TPWODL	Date of Issue: 01/08/2023

8. That the Contractor and its subcontractors shall abide by all the safety guidelines as per Safety Manual, Contract Safety Management and other guidelines issued from time to time by Discom during the contract period.
9. That in case the Contractor and/or any of its Subcontractor fail to ensure the compliance as required in terms of this undertaking the Contractor shall keep and hold Discom / its directors / officers / employees indemnified against any / all losses / damage / expense / liability / fines / compensation / claims / action / prosecutions or the like which might be suffered by Discom or to which Discom might get exposed to as a result of any breach /wilful negligence /deliberate default on the part of the Contractor /Subcontractor in complying with the same. Contractor shall also furnish any press release, clarification etc. if sought by Discom for any near miss or safety violations, accidents, which are attributable to fault of Contractor.

DEPONENT

VERIFICATION

Verified aton this _Day of _____ 20__ that the contents of the above affidavit are true and correct and nothing material has been concealed therefrom

CONFIDENTIAL

The Tata Power Company Ltd	     	Contractor's Safety Code of Conduct
Document no TPSMS/GSP/ CSM/015/REV 07		Date of Issue: 01/08/2023

Annexure to Appendix 3 : Safety Terms and Conditions Safety Retention Matrix

5.5 Safety performance retention(R7): A certain percentage of the bill value will be retained against every running bill as safety performance retention. The amount will be released with the last invoice or every six-month based on Safety Performance Score of contractors. The retention amount will be calculated based on contract value as below. (R7)

Risk Category-(R7)	Contract Value	Retention Amount (%)
<u>Very high/High risk job/ Medium Risk jobs</u>	Up to 10 Lakhs	2.5
<u>Very high/High risk job/ Medium Risk jobs</u>	10 – 50 Lakhs	2
<u>Low/Very Low Risk jobs</u>	10 – 50 Lakhs	1
<u>Very high/High risk job</u>	0.5 to 10 Cr	2
<u>Medium Risk jobs</u>	0.5 to 10 Cr	1.5
<u>Low/Very Low Risk jobs</u>	0.5 to 10 Cr	1
<u>Very high/High risk job</u>	>10 Cr	1.5
<u>Medium Risk jobs</u>	>10 Cr	1

The Tata Power Company Ltd	  	Contractor's Safety Code of Conduct
Document no TPSMS/GSP/CSM/015/REV 07		Date of Issue: 01/08/2023

Appendix 6: CSM F6 - Safety Competency Assessment Form (Template)

Name of the Vendor/Bidder:
Name of the Sub Vendor (If job is given to Sub Vendor):
Description of the Job:
Request for Quotation (RFQ) No.:

Vendor/Bidder to mandatorily provide the below safety competency related information:

1. Proposed Manpower Deployment Schedule :-

Type of manpower	Qualification	Experience	Month 1	Month 2	Month 3
<u>Project /AMC Manager(R7)</u>						
Site In Charge						
Safety Manager						
Safety Officer						
Supervisors						
Technicians						
High Skilled workmen						
Skilled workmen						
Semiskilled workmen						
Lineman						
Helpers						
Drivers						
Unskilled						
<u>Others(R7)</u>						

Instruction to Bidders:

- i. Indicate the overall site manpower deployment schedule as above
- ii. Indicate direct or subcontracted employees by using color code given below:
 - Direct Bidder Employee – Green**
 - Partly Direct / partly Subcontracted – Yellow**
 - 4.3.5 **Subcontracted – Red** *If subcontractor detail is not available at stage of Bid evaluation, then this can be agreed with Order manager or Engineer in charge before deployment Ensure that all sub-contractors follow the Tata Power Safety Procedure and agreed CSM F9 Site Safety Management Plan.R7*

iii. Against each category, indicate minimum educational qualification and work experience

The Tata Power Company Ltd	    	<i>Contractor's Safety Code of Conduct</i>
Document no TPSMS/GSP/ CSM/015/REV 07		Date of Issue: 01/08/2023

- iv. Add rows to include other specialized manpower, if any.
- v. Extend columns to cover the entire duration of the proposed contract.
- vi. If the operation is in shifts, then indicate shift in charge and / or safety officers required for each shift operation.

2. List of Tools, Tackles, Machines and Equipment: -

Bidder/ Vendor to provide the list of tools, tackles, equipment to be used during the job / project execution. Bidder/Vendor to ensure that all the lifting tools and tackles, pressure vessels are duly certified by the competent person authorised by the Chief Inspector of Factories of the respective state prior to start of the job

Sr. No	Description of Tools / Tackles	Capacity / Rating	Quantity	Make	Year of manufacture	Remarks
1						
2						
3						
4						
5						
.....						

3. Safety Records:

Bidder to provide the details of fatalities and lost workday cases (LWDC), occurred in last three years (data to be provided for the last completed FY and preceding 2 years).

Description	Safety Data for current and Last 3 Years			
	Current Year	Year 1 (Last FY)	Year 2	Year 3
		20__ - __	20__ - __	20__ - __
Fatalities (Nos.)				
Lost Workday Cases (Nos.)				

In case of no fatalities, LWDC during any year, the form may be filled stating NIL against the respective year. Bidders are encouraged to also submit the RCA / incident investigation reports and the learning's implemented out of the above reported incidents

4. Job Safety Plan/ Method Statement:

Bidder to provide / enclose a detailed Site/Job Safety Plan along with a Method statement detailing the execution philosophy (how the bidder intends to execute the Job/Project), identifying all key activities which are required to be performed by the contractor at Site.

The Tata Power Company Ltd	     	Contractor's Safety Code of Conduct
Document no TPSMS/GSP/CSM/015/REV 07		Date of Issue: 01/08/2023

Bidder to also list down all high-risk activities and provide the Hazard Identification and Risk Assessment (HIRA) for all such high-risk activities involved in the site work.

(Use Method Statement template attached as Appendix 9)

5. PPE Requirement -R7

Division/DISCOM Requirement	Bidders Response
The Bidder/Vendor shall ensure that all PPE of Approved standards as per CSM F8 – PPE Requirements shall be always available and shall be used by his employees with no exception whatsoever. Bidders to also ensure Standard PPE matrix of Tata Power to be followed for all activities.	
10% Buffer stock of PPEs to be provided by bidders at each circle to meet any contingency	
Bidder will ensure that sample PPEs to be submitted/approved by Safety Department along with EIC at the time of submission of Safety bids for evaluation In case bidder manpower found using substandard or any PPEs which are not approved by the Tata Power-Division /DISCOM representative, then Tata Power-Division /DISCOM will provide the same to manpower deployed at the cost of bidders.	

6. Vehicle Deployment: Bidders to provide details of all vehicles deployed during execution of work-(R7)

S. No.	Vehicle No.	Vehicle Type	Location	EV/CNG/Diesel/Petrol	Year	Whether CNG endorsed on RC

The Tata Power Company Ltd	     	<i>Contractor's Safety Code of Conduct</i>
<i>Document no TPSMS/GSP/CSM/015/REV 07</i>		<i>Date of Issue: 01/08/2023</i>

7. Crane Deployment-(R7): Bidders to provide details of crane to be deployed during the execution of work as and when required. Bidders to provide approved new gen crane ACE Model SX150, ACE FX150 and Escorts Model TRX 1550.

SI No	Crane No	Location	Year

8. Training Records-(R7): Bidders to provide training records of employees deployed for the execution of work during last one year. These training includes OHS (Occupational Health and Safety) Training, Training on SOP/Work Procedures and Medical Emergency trainings imparted at their own facility, cost, and expenses. Bidders to provide the following details:

Tata Power-Division /DISCOM Requirement	Bidders Response
Training records of employees at their own facility, cost, and expenses for last one year	
Training facility available with Bidders	
Future road map for enhancing the competency of workforce	

9. Rewards and Recognition-(R7): Bidders to provide the details of process deployed in their organization for sharing and resolution of safety concerns raised by their employees. Also, bidders to provide the details of Rewards and Recognition process in their organization for safety to encourage the morale of their workforce.

10. Management System Certification: -

Sr.No	Certification	Yes / No	If Yes, Year of Certification	If No, Target date for Certification
1	ISO 9001			
2	ISO 14001			
3	ISO 45001			
4	Any other (Specify....)			

Note: Please attach certificates to support above. In case not accredited for above but applied for, application letters may be attached.

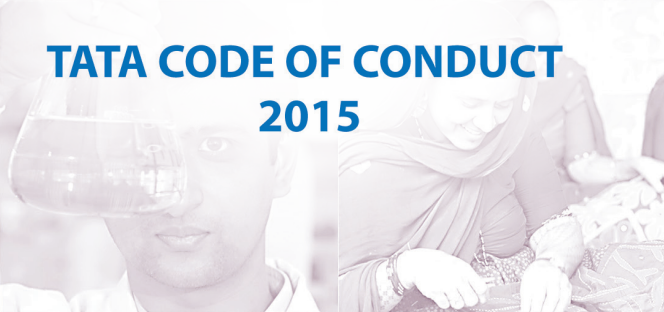

**TATA CODE OF CONDUCT
2015**



LEADERSHIP THAT INSPIRES

For over 100 years, the Tata group has been led by visionaries who have stayed true to the vision of the founder, Jamsetji Tata.

A vision that placed the greater good of society at par with business growth.

A vision that put into practice pioneering social initiatives that changed the way responsible business was run.

And a vision that brought into the group a strong social conscience.



We do not claim to be more unselfish, more generous or more philanthropic than other people. But we think we started on sound and straightforward business principles, considering the interests of the shareholders our own, and the health and welfare of the employees, the sure foundation of our success.

Jamsetji Tata
Founder of the Tata group
Chairman (1868 – 1904)

CONTENTS

Foreword	3
A Our values.....	4
B Scope and purpose of this Code.....	5
C Our core principles.....	7
D Our employees.....	9
E Our customers.....	18
F Our communities and the environment.....	21
G Our value-chain partners.....	23
H Our financial stakeholders.....	25
I Governments.....	27
J Our group companies.....	29
Raising concerns	30
Accountability	31
Acknowledgement sheet	33

FOREWORD

Tata companies have consistently adhered to the values and ideals articulated by the Founder for over 150 years. The Tata Code of Conduct was first formalized by Mr Ratan Tata. It articulates the Group's values and ideals that guide and govern the conduct of our companies as well as our colleagues in all matters relating to business. Today, the Code is a bedrock on which we base our individual, as well as leadership commitments to core Tata values.

The Tata Code of Conduct outlines our commitment to each of our stakeholders, including the communities in which we operate, and is our guiding light when we are sometimes faced with business dilemmas that leave us at ethical crossroads. The Code is also dynamic in that it has been periodically refreshed in order to remain contemporary and contextual to the changes in law and regulations. However it remains unaltered at its core.

Our stellar reputation and success as a business entity has been defined by the powerful commitment and adherence to the core values and principles expressed in this Code, by all our employees, directors and partners. I trust every Tata colleague and Tata company will continue to not only comply with the laws and regulations that govern our business interests around the world, but will continue to set new standards of ethical conduct that will generate deep respect and inspire emulation by others.

N. Chandrasekaran

21st February, 2017



A. OUR VALUES

TATA has always been values-driven. The five core values that underpin the way we conduct our business activities are:



INTEGRITY

We will be fair, honest, transparent and ethical in our conduct; everything we do must stand the test of public scrutiny.

UNITY

We will invest in our people and partners, enable continuous learning, and build caring and collaborative relationships based on trust and mutual respect.

RESPONSIBILITY

We will integrate environmental and social principles in our businesses, ensuring that what comes from the people goes back to the people many times over.

PIONEERING

We will be bold and agile, courageously taking on challenges, using deep customer insight to develop innovative solutions.

EXCELLENCE

We will be passionate about achieving the highest standards of quality, always promoting meritocracy.

These universal values serve as the foundation for the Tata Code of Conduct. They find expression within the value system of every Tata company.

B. SCOPE AND PURPOSE OF THIS CODE

1. This Code sets out how we behave with:
 - our employees, or those who work with us;
 - our customers;
 - the communities and the environment in which we operate;
 - our value-chain partners, including suppliers and service providers, distributors, sales representatives, contractors, channel partners, consultants, intermediaries and agents;
 - our joint-venture partners or other business associates;
 - our financial stakeholders;
 - the governments of the countries in which we operate; and
 - our group companies.
 2. In this Code, “we or us” means our company, our executive directors, officers, employees and those who work with us, as the context may require.
 3. The term “our group companies” in this Code typically means companies Tata Sons intends for this Code to apply to, and / or to whom Tata Sons has issued this Code.
 4. This Code sets out our expectations of all those who work with us. We also expect those who deal with us to be aware that this Code underpins everything we do, and in order to work with us they need to act in a manner consistent with it.
-

REMEMBER...

It is our commitment to protect our reputation and our brand equity by adhering to the values and principles set out in this Code. By doing so, we strengthen our unique culture and identity.

OUR CORE PRINCIPLES



The Tata philosophy of management has always been, and is today more than ever, that corporate enterprises must be managed not merely in the interests of their owners, but equally in those of their employees, of the consumers of their products, of the local community and finally of the country as a whole.

J.R.D. Tata

Chairman, Tata Sons (1938 – 1991)

C. OUR CORE PRINCIPLES

1. We are committed to operating our businesses conforming to the highest moral and ethical standards. We do not tolerate bribery or corruption in any form. This commitment underpins everything that we do.
2. We are committed to good corporate citizenship. We treat social development activities which benefit the communities in which we operate as an integral part of our business plan.
3. We seek to contribute to the economic development of the communities of the countries and regions we operate in, while respecting their culture, norms and heritage. We seek to avoid any project or activity that is detrimental to the wider interests of the communities in which we operate.
4. We shall not compromise safety in the pursuit of commercial advantage. We shall strive to provide a safe, healthy and clean working environment for our employees and all those who work with us.
5. When representing our company, we shall act with professionalism, honesty and integrity, and conform to the highest moral and ethical standards. In the countries we operate in, we shall exhibit culturally appropriate behaviour. Our conduct shall be fair and transparent and be perceived as fair and transparent by third parties.
6. We shall respect the human rights and dignity of all our stakeholders.
7. We shall strive to balance the interests of our stakeholders, treating each of them fairly and avoiding unfair discrimination of any kind.
8. The statements that we make to our stakeholders shall be truthful and made in good faith.
9. We shall not engage in any restrictive or unfair trade practices.
10. We shall provide avenues for our stakeholders to raise concerns or queries in good faith, or report instances of actual or perceived violations of our Code.
11. We shall strive to create an environment free from fear of retribution to deal with concerns that are raised or cases reported in good faith. No one shall be punished or made to suffer for raising concerns or making disclosures in good faith or in the public interest.
12. We expect the leaders of our businesses to demonstrate their commitment to the ethical standards set out in this Code through their own behaviour and by establishing appropriate processes within their companies.
13. We shall comply with the laws of the countries in which we operate and any other laws which apply to us. With regard to those provisions of the Code that are explicitly dealt with under an applicable law or employment terms, the law and those terms shall take precedence. In the event that the standards prescribed under any applicable law are lower than that of the Code, we shall conduct ourselves as per the provisions of the Code.

REMEMBER...

“Good faith” means having a reasonable belief that the information you have provided is truthful. It does not mean having ‘all the evidence’ about the potential violation or case reported.

OUR EMPLOYEES



Once you got the best people, the people who shared our values and ideals, we left them free to act on their own. We do not fetter them. We encourage them and give them opportunities for leadership.

J.R.D. Tata

Chairman, Tata Sons (1938 – 1991)

D. OUR EMPLOYEES

Equal opportunity employer

1. We provide equal opportunities to all our employees and to all eligible applicants for employment in our company. We do not unfairly discriminate on any ground, including race, caste, religion, colour, ancestry, marital status, gender, sexual orientation, age, nationality, ethnic origin, disability or any other category protected by applicable law.
2. When recruiting, developing and promoting our employees, our decisions will be based solely on performance, merit, competence and potential.
3. We shall have fair, transparent and clear employee policies which promote diversity and equality, in accordance with applicable law and other provisions of this Code. These policies shall provide for clear terms of employment, training, development and performance management.

Q&A

A job requirement entails extensive travel. One of the candidates has excellent relevant experience and qualifications. However, this candidate is a single parent. As a result, I feel such a situation would significantly hinder this candidate's ability to cope with the job requirement. What should I do?

In accordance with the Code, the decision to recruit an employee should be based upon merit. We cannot make a presumption that the candidate would not be able to meet the travel requirements of the job. All eligible candidates should be provided with equal opportunity to demonstrate or justify that they can cope with the travel requirements of the job. Being a single parent cannot be a ground to be discriminated against at any stage of recruitment or ongoing employment in our company.

REMEMBER...

We do not tolerate harassment in any form and therefore we expect every employee to discourage such misdemeanours in the workplace.

Dignity and respect

4. Our leaders shall be responsible for creating a conducive work environment built on tolerance, understanding, mutual cooperation and respect for individual privacy.
5. Everyone in our work environment must be treated with dignity and respect. We do not tolerate any form of harassment, whether sexual, physical, verbal or psychological.
6. We have clear and fair disciplinary procedures, which necessarily include an employee's right to be heard.
7. We respect our employees' right to privacy. We have no concern with their conduct outside our work environment, unless such conduct impairs their work performance, creates conflicts of interest or adversely affects our reputation or business interests.

Human rights

8. We do not employ children at our workplaces.
9. We do not use forced labour in any form. We do not confiscate personal documents of our employees, or force them to make any payment to us or to anyone else in order to secure employment with us, or to work with us.

Bribery and corruption

10. Our employees and those representing us, including agents and intermediaries, shall not, directly or indirectly, offer or receive any illegal or improper payments or comparable benefits that are intended or perceived to obtain undue favours for the conduct of our business.

REMEMBER...

Violation by even a single employee of any law relating to anti-bribery, anti-corruption, anti-competition, data privacy, etc. could result in severe financial penalties and cause irreparable reputational damage to the company.

Gifts and hospitality

11. Business gifts and hospitality are sometimes used in the normal course of business activity. However, if offers of gifts or hospitality (including entertainment or travel) are frequent or of substantial value, they may create the perception of, or an actual conflict of interest or an 'illicit payment'. Therefore, gifts and hospitality given or received should be modest in value and appropriate, and in compliance with our company's gifts and hospitality policy.

Freedom of association

12. We recognise that employees may be interested in joining associations or involving themselves in civic or public affairs in their personal capacities, provided such activities do not create an actual or potential conflict with the interests of our company. Our employees must notify and seek prior approval for any such activity as per the 'Conflicts of Interest' clause of this Code and in accordance with applicable company policies and law.

REMEMBER...

As a general rule, we may accept gifts or hospitality from a business associate, only if such a gift:

- has modest value and does not create a perception (or an implied obligation) that the giver is entitled to preferential treatment of any kind;
- would not influence, or appear to influence, our ability to act in the best interest of our company;
- would not embarrass our company or the giver if disclosed publicly.

The following gifts are never appropriate and should never be given or accepted:

- gifts of cash or gold or other precious metals, gems or stones;
- gifts that are prohibited under applicable law;
- gifts in the nature of a bribe, payoff, kickback or facilitation payment*;
- gifts that are prohibited by the gift giver's or recipient's organisation; and
- gifts in the form of services or other non-cash benefits (e.g. a promise of employment).

(*'Facilitation' payment is a payment made to secure or speed up routine legal government actions, such as issuing permits or releasing goods held in customs.)

Working outside employment with us

13. Taking employment, accepting a position of responsibility or running a business outside employment with our company, in your own time, with or without remuneration, could interfere with your ability to work effectively at our company or create conflicts of interest. Any such activity must not be with any customer, supplier, distributor or competitor of our company. Our employees must notify and seek prior approval for any such activity as per the 'Conflicts of Interest' clause of this Code and in accordance with applicable company policies and law.

Integrity of information and assets

14. Our employees shall not make any wilful omissions or material misrepresentation that would compromise the integrity of our records, internal or external communications and reports, including the financial statements.
15. Our employees and directors shall seek proper authorisation prior to disclosing company or business-related information, and such disclosures shall be made in accordance with our company's media and communication policy. This includes disclosures through any forum or media, including through social media.
16. Our employees shall ensure the integrity of personal data or information provided by them to our company. We shall safeguard the privacy of all such data or information given to us in accordance with applicable company policies or law.
17. Our employees shall respect and protect all confidential information and intellectual property of our company.
18. Our employees shall safeguard the confidentiality of all third party intellectual property and data. Our employees shall not misuse such intellectual property and data that comes into their possession and shall not share it with anyone, except in accordance with applicable company policies or law.
19. Our employees shall promptly report the loss, theft or destruction of any confidential information or intellectual property and data of our company or that of any third party.

Q&A

I am an accountant in the finance department of my company. Due to my artistic skills, I received an offer to pen cartoons for a children's publication for which I would receive compensation. I plan to undertake this activity during week-ends. What should I do before accepting this offer?

Before accepting the offer, you should ascertain whether the company policies and rules require you to make a disclosure to your supervisor so that the company may determine whether your undertaking this activity adversely affects our company's interests. On confirmation from the company that it does not do so, you would be free to take up the activity. It is also your duty to bring to the attention of the company whenever there is any change in the situation you have disclosed.

20. Our employees shall use all company assets, tangible and intangible, including computer and communication equipment, for the purpose for which they are provided and in order to conduct our business. Such assets shall not be misused. We shall establish processes to minimise the risk of fraud, and misappropriation or misuse of our assets.
21. We shall comply with all applicable anti-money laundering, anti-fraud and anti-corruption laws and we shall establish processes to check for and prevent any breaches of such laws.

Insider trading

22. Our employees must not indulge in any form of insider trading nor assist others, including immediate family, friends or business associates, to derive any benefit from access to and possession of price sensitive information that is not in the public domain. Such information would include information about our company, our group companies, our clients and our suppliers.

Q&A

Our company has recently announced the launch of a new business initiative. In connection with this, your friend who is a journalist with a leading business newspaper has asked you to provide some information that he could cover in his forthcoming article. He has promised not to quote you, or reveal your identity. Should you be giving him this information?

No. You should not be sharing information of this nature with the media, even if it is assured that the source would remain anonymous. Only authorised personnel in the company are permitted to speak to the media and provide information of this nature.

Our company has a “Use of Social Media” policy that lays down the “dos and don’ts” for use of social media even if you may access such media on your own time. Why is there such a policy?

External communication is a serious matter. It must be carefully managed because information put out with reference to our company or its businesses needs to be clear, truthful and not violate any undertakings we have given to other parties. In each business there are managers nominated to authorise and make different types of statements to the outside world. These managers should be consulted about any request for information you may receive or information you think we should give out.

In using social media, in particular blogs or social networking sites, you should exercise great caution while talking about our company or the business we do. It may feel like you are chatting with friends or expressing a personal opinion but even while doing so you cannot share any confidential information of our company.

REMEMBER...

We must respect the property rights of others by never misusing their assets, intellectual property or trade secrets, including the copying or downloading of unauthorised software, trademarks, copyrighted material or logos. We should never make unauthorised copies of computer software programs or use unlicensed personal software on company computers.

Prohibited drugs and substances

23. Use of prohibited drugs and substances creates genuine safety and other risks at our workplaces. We do not tolerate prohibited drugs and substances from being possessed, consumed or distributed at our workplaces, or in the course of company duties.

Conflicts of interest

24. Our employees and executive directors shall always act in the interest of our company and ensure that any business or personal association *including close personal relationships* which they may have, does not create a conflict of interest with their roles and duties in our company or the operations of our company. Further, our employees and executive directors shall not engage in any business, relationship or activity, which might conflict with the interest of our company or our group companies.
25. Should any actual or potential conflicts of interest arise, the concerned person must immediately report such conflicts and seek approvals as required by applicable law and company policy. The competent authority shall revert to the employee within a reasonable time as defined in our company's policy, so as to enable the concerned employee to take necessary action as advised to resolve or avoid the conflict in an expeditious manner.
26. In the case of all employees other than executive directors, the Chief Executive Officer / Managing Director shall be the competent authority, who in turn shall report such cases to the Board of Directors on a quarterly basis. In case of the Chief Executive Officer / Managing Director and executive directors, the Board of Directors of our company shall be the competent authority.

Q&A

You are responsible for maintaining our company's customer database. One of your friends is starting a business venture and requests you to share a few particulars from this database for marketing purposes of his business. He assures you that he would keep the data as well as his source confidential. Should you do so?

No. You should respect the confidentiality of customer information and not share any part of the database with any person without due authorisation.

You have access to revenue numbers of different business units of our company. While having a conversation with you over evening drinks, your friend enquires about the financial performance of our company. You do not share detailed information with your friend, but share approximate revenue figures. Is this conduct of yours correct?

No, it is not. You are not permitted to share financial information of our company with others who do not need to know this information. Financial information should always be safeguarded and disclosed only on a need-to-know basis after obtaining requisite approvals. Sharing of any price sensitive information that is not generally available with the public could also lead to violation of applicable insider trading laws.

27. Notwithstanding such or any other instance of conflict of interest that exists due to historical reasons, adequate and full disclosure by interested employees shall be made to our company's management. At the time of appointment in our company, our employees and executive directors shall make full disclosure to the competent authority, of any interest leading to an

actual or potential conflict that such persons or their immediate family (including parents, siblings, spouse, partner, children) or persons with whom they enjoy close personal relationships, may have in a family business or a company or firm that is a competitor, supplier, customer or distributor of, or has other business dealings with, our company.

REMEMBER...

A conflict of interest could be any known activity, transaction, relationship or service engaged in by an employee, his/her immediate family (including parents, siblings, spouse, partner, and children), relatives or a close personal relationship, which may cause concern (based upon an objective determination) that the employee could not or might not be able to fairly perform his/her duties to our company.

Examples of Potential Conflicts of Interest

A conflict of interest, actual or potential, arises where, directly or indirectly, an employee or executive director:

- (a) engages in a business, activity or relationship with anyone who is party to a transaction with our company;
- (b) is in a position to derive an improper benefit, personally or for any family member or for any person in a close personal relationship, by making or influencing decisions relating to any transaction;
- (c) conducts business on behalf of our company or is in a position to influence a decision with regard to our company's business with a supplier or customer where a relative of, or a person in close personal relationship with, an employee or executive director is a principal officer or representative, resulting in a personal benefit or a benefit to the relative;
- (d) is in a position to influence decisions with regard to award of benefits such as increase in salary or other remuneration, posting, promotion or recruitment of a relative or a person in close personal relationship employed in our company or any of our group companies;
- (e) undertakes an activity by which the interest of our company or our group companies can be compromised or defeated; or
- (f) does anything by which an independent judgement of our company's or our group companies' best interest cannot be exercised.

28. If there is a failure to make the required disclosure and our management becomes aware of an instance of conflict of interest that ought to have been disclosed by an employee or executive director, our management shall take a serious view of the matter and consider suitable disciplinary action as per the terms of employment. In all such matters, we shall follow clear and fair disciplinary procedures, respecting the employee's right to be heard.

Examples of activities normally approved (post-disclosure) as per applicable company policy

Acceptance of a position of responsibility (whether for remuneration or otherwise) in the following cases would typically be permitted, provided the time commitments these demand do not disturb or distract from the employee's primary duties and responsibilities in our company, and are promptly disclosed to the relevant competent authority:

- (a) Directorships on the Boards of any of our group companies, joint ventures or associate companies.
- (b) Memberships/positions of responsibility in educational/professional bodies, where such association will promote the interests of our company.
- (c) Memberships or participation in government committees/bodies or organisations.

Q&A

You are in a relationship with a colleague who has been recently moved into your team and would now be reporting to you. What should you do?

Romantic or close personal relationships with another employee where a reporting relationship exists and one is responsible for evaluating the other's performance, is likely to create a conflict of interest. In such a situation, you would need to report the potential conflict to your supervisor.

Your company is submitting a proposal to a company in which you were previously employed. You have confidential information pertaining to your previous employer, which you believe will help your present employer in winning the contract. Should you share this information?

No. You should not share this information with your company since it relates to confidential information of a third party. Your company respects its employees' duty to protect confidential information that they may have relating to their previous employers.

You are the purchasing manager in the procurement department of your company. You receive an invitation from a supplier to attend a premier sporting event as her guest. This particular supplier is one of the vendors who has submitted a proposal for an open tender issued by your company. Should you accept the invitation?

No. You should not accept the invitation in this instance. Since you are in a key decision-making role for the tender, any unusual benefit that you receive could be perceived as an inducement that could compromise your objectivity.

OUR CUSTOMERS



We have continued to enjoy prosperity, even with adverse times to fight against. Our relations with all concerned are the most friendly. We have maintained the same character for straight-forward dealing with our constituents and customers. Our productions have continued to be of the same high quality, and therefore command the best reputation and realise the highest prices. ... I mention these facts only to point out that with honest and straight-forward business principles, close and careful attention to details, and the ability to take advantage of favourable opportunities and circumstances, there is a scope for success.

Jamsetji Tata

Founder of the Tata group
Chairman, Tata Sons (1868 – 1904)

E. OUR CUSTOMERS

Products and services

1. We are committed to supplying products and services of world-class quality that meet all applicable standards.
2. The products and services we offer shall comply with applicable laws, including product packaging, labelling and after-sales service obligations.
3. We shall market our products and services on their own merits and not make unfair or misleading statements about the products and services of our competitors.

Export controls and trade sanctions

4. We shall comply with all relevant export controls or trade sanctions in the course of our business.

Fair competition

5. We support the development and operation of competitive open markets and the liberalisation of trade and investment in each country and market in which we operate.
6. We shall not enter into any activity constituting anti-competitive behaviour such as abuse of market dominance, collusion, participation in cartels or inappropriate exchange of information with competitors.
7. We collect competitive information only in the normal course of business and obtain the same through legally permitted sources and means.

Dealings with customers

8. Our dealings with our customers shall be professional, fair and transparent.
 9. We respect our customers' right to privacy in relation to their personal data. We shall safeguard our customers' personal data, in accordance with applicable law.
-

Q&A

You are the Regional Sales Manager of our company. You have become a member of an “informal group”, on an instant messaging service, whose members are the regional sales heads of our company’s competitors. The administrator of the group has requested an in-person meeting to informally discuss market conditions and brainstorm on “pricing strategy” from an industry perspective. What should you do?

Any meeting with competitors, especially to discuss “pricing strategy”, could be an attempt to promote an anti-competitive practice or manipulate prices. You should respond by declining this invitation and exiting the “informal group”. You should also report this incident to your supervisor and your Legal department.

You are attending a customer meeting with a colleague, and your colleague makes an untruthful statement about the company’s services. What should you do?

You should assist your colleague in correcting the inaccuracy during the meeting if possible. If this is not possible, raise the issue with your colleague after the meeting to enable him/her or the company to correct any misrepresentation made to the customer.

While working on a customer project, you receive a call from your colleague. He used to manage that customer account before you took over his role. He recalls that he had worked with the customer on developing a new ordering system which he thinks would be beneficial for another customer and requests you to send him the project details. What should you do?

You must not share this information without specific approval of the customer; you are not permitted to use a customer’s assets, including software, for another customer or for any personal use.

REMEMBER...

Striving for excellence in the standards of our work and in the quality of our goods and services is a core Tata value. It is the unwavering practice of this value that builds and sustains customer trust in our brand.

OUR COMMUNITIES AND THE ENVIRONMENT



“In a free enterprise, the community is not just another shareholder in business but is in fact the very purpose of its existence.”

Jamsetji Tata

Founder of the Tata group
Chairman, Tata Sons (1868 – 1904)

F. OUR COMMUNITIES AND THE ENVIRONMENT

Communities

1. We are committed to good corporate citizenship, and shall actively assist in the improvement of the quality of life of the people in the communities in which we operate.
2. We engage with the community and other stakeholders to minimise any adverse impact that our business operations may have on the local community and the environment.
3. We encourage our workforce to volunteer on projects that benefit the communities in which we operate, provided the principles of this Code, where applicable, and in particular the 'Conflicts of Interest' clause are followed.

The environment

4. In the production and sale of our products and services, we strive for environmental sustainability and comply with all applicable laws and regulations.
5. We seek to prevent the wasteful use of natural resources and are committed to improving the environment, particularly with regard to the emission of greenhouse gases, consumption of water and energy, and the management of waste and hazardous materials. We shall endeavour to offset the effect of climate change in our activities.

OUR VALUE-CHAIN PARTNERS



If we had done some of the things that some other groups have done, we would have been twice as big as we are today.
But we didn't, and I would not have it any other way.

J.R.D. Tata

Chairman, Tata Sons (1938 – 1991)

(on the pace of expansion of the Tata group in the 1960s and 70s)

G. OUR VALUE-CHAIN PARTNERS

1. We shall select our suppliers and service providers fairly and transparently.
2. We seek to work with suppliers and service providers who can demonstrate that they share similar values. We expect them to adopt ethical standards comparable to our own.
3. Our suppliers and service providers shall represent our company only with duly authorised written permission from our company. They are expected to abide by the Code in their interactions with, and on behalf of us, including respecting the confidentiality of information shared with them.
4. We shall ensure that any gifts or hospitality received from, or given to, our suppliers or service providers comply with our company's gifts and hospitality policy.
5. We respect our obligations on the use of third party intellectual property and data.

Q&A

You head the procurement function in our company. You have tight budgetary constraints for a project that you are working on. In order to complete the project within the targeted costs, you intend to request your supplier to provide you an exceptional discount on this project order on the understanding that you would “make it up to him” in future orders. Would you be violating the Code?

Yes, you would. Inducement in any form, including future benefits to the supplier, could compromise your ability to act objectively and in the best interests of the company and therefore must be avoided.

REMEMBER...

Our value-chain partners would include our suppliers and service providers, distributors, sales representatives, contractors, channel partners, consultants, intermediaries and agents; joint-venture partners and other business associates.

OUR FINANCIAL STAKEHOLDERS



Ethical behaviour in business – in every sphere and with all constituents – has been the bedrock on which the Tata group has built, and operates, its enterprises. This has been an article of faith for the group ever since its inception, a fundamental element of our cherished heritage and the essence of our way of life.

Ratan Tata

Chairman, Tata Sons (1991 – 2012)

H. OUR FINANCIAL STAKEHOLDERS

1. We are committed to enhancing shareholder value and complying with laws and regulations that govern shareholder rights.
 2. We shall inform our financial stakeholders about relevant aspects of our business in a fair, accurate and timely manner and shall disclose such information in accordance with applicable law and agreements.
 3. We shall keep accurate records of our activities and shall adhere to disclosure standards in accordance with applicable law and industry standards.
-

GOVERNMENTS



Business, as I have seen it, places one great demand on you; it needs you to impose a framework of ethics, values, fairness and objectivity on yourself at all times. It is not easy to do this; you cannot impose it on yourself forcibly because it has to become an integral part of you.

Ratan Tata

Chairman, Tata Sons (1991 – 2012)

I. GOVERNMENTS

Political non-alignment

1. We shall act in accordance with the constitution and governance systems of the countries in which we operate. We do not seek to influence the outcome of public elections, nor to undermine or alter any system of government. We do not support any specific political party or candidate for political office. Our conduct must preclude any activity that could be interpreted as mutual dependence/favour with any political body or person, and we do not offer or give any company funds or property or other resources as donations to any specific political party, candidate or campaign.

Any financial contributions considered by our Board of Directors in order to strengthen democratic forces through a clean electoral process shall be extended only through the Progressive Electoral Trust in India, or by a similar transparent, duly-authorised, non-discriminatory and non-discretionary vehicle outside India.

Government engagement

2. We engage with the government and regulators in a constructive manner in order to promote good governance. We conduct our interactions with them in a manner consistent with our Code.
3. We do not impede, obstruct or improperly influence the conclusions of, or affect the integrity or availability of data or documents for any government review or investigation.

OUR GROUP COMPANIES



I do not think anyone was on par with Jamsetji as an industrial visionary. But that is not the sole reason why I have been an admirer of Jamsetji. The major reason was his sense of values, sterling values, which he imparted to this group. If someone were to ask me, what holds the Tata companies together, more than anything else, I would say it is our shared ideals and values which we have inherited from Jamsetji Tata.

J.R.D. Tata

Chairman, Tata Sons (1938 – 1991)

J. OUR GROUP COMPANIES

1. We seek to cooperate with our group companies, including joint ventures, by sharing knowledge, physical resources, human and management resources and adopting leading governance policies and practices in accordance with applicable law including adherence to competition law, where relevant.
2. We shall strive to achieve amicable resolution of any dispute between us and any of our group companies, through an appropriate dispute resolution mechanism so that it does not adversely affect our business interests and stakeholder value.
3. We shall have processes in place to ensure that no third party or joint venture uses the TATA name/brand to further its interests without proper authorisation.
4. Our Board of Directors shall consider for adoption policies and guidelines periodically formulated by Tata Sons and circulated to group companies.

Q&A

You are in the process of selecting potential vendors for an IT project in our company. In the final shortlist of two companies, one is a new start-up with limited references and a lower price-quotation, while the other is a Tata company with thirty years of implementation experience and good references, but a marginally higher quote for the same job. With all other parameters of choice being nearly equal, which company should you select for the job?

While price is undoubtedly an important criterion for decision making, it is clearly not the only one to be evaluated. You may also need to consider good customer references, proven track record and shared value systems in order to decide on your IT partner.

You are in the process of selecting potential vendors for a project. One of the three finalists is a group company. In reviewing the final proposals, you rank the group company second out of the three proposals based on pricing and total cost of ownership, and select the first-ranked vendor. Is this the right decision?

Yes. You should select the vendor that, on its own merits, is the vendor that is most appropriate for your company's requirements. You should not select a group company only because of its affiliation.

RAISING CONCERNS

We encourage our employees, customers, suppliers and other stakeholders to raise concerns or make disclosures when they become aware of any actual or potential violation of our Code, policies or law. We also encourage reporting of any event (actual or potential) of misconduct that is not reflective of our values and principles.

Avenues available for raising concerns or queries or reporting cases could include:

- immediate line manager or the Human Resources department of our company
- designated ethics officials of our company
- the 'confidential reporting' third party ethics helpline (if available)
- any other reporting channel set out in our company's 'Whistleblower' policy.

We do not tolerate any form of retaliation against anyone reporting legitimate concerns. Anyone involved in targeting such a person will be subject to disciplinary action.

If you suspect that you or someone you know has been subjected to retaliation for raising a concern or for reporting a case, we encourage you to promptly contact your line manager, the company's Ethics Counsellor, the Human Resources department, the MD/CEO or the office of the group's Chief Ethics Officer.

Q&A

My supervisor has asked me to do something which I believe may be illegal. I am afraid if I do not do what I am told, I could lose my job. Should I do it?

No. Breaking the law is never an option. Discuss the situation with your supervisor to be certain that you both understand the facts. If your concerns are not resolved, contact a higher level supervisor, the Ethics Counsellor, the Legal department or report them via the company's confidential reporting system, if available.

I feel that my supervisor is treating me unfairly for reporting a concern to the Ethics Counsellor. What should I do?

Retaliation against anyone who raises a concern is a violation of the Code. You should therefore promptly report this action of your supervisor to the Ethics Counsellor or the MD/CEO of your company or via the company's confidential reporting system, if available.

ACCOUNTABILITY

This Code is more than a set of prescriptive guidelines issued solely for the purpose of formal compliance. It represents our collective commitment to our value system and to our core principles.

Every person employed by us, directly or indirectly, should expect to be held accountable for his/her behaviour. Should such behaviour violate this Code,

they may be subject to action according to their employment terms and relevant company policies.

When followed in letter and in spirit, this Code is 'lived' by our employees as well as those who work with us. It represents our shared responsibility to all our stakeholders, and our mutual commitment to each other.

SPEAK UP...

If you are unsure whether a particular action you are about to take is consistent with the principles set forth in the Code, ask yourself:

- Could it directly or indirectly endanger someone or cause them injury?
- Is it illegal/unlawful or out of line with our policies and procedures?
- Does my conscience reject it? Does it conflict with my personal values?
- Would I feel uncomfortable if the story appeared in the media? Would it shame my company, spouse, partner, parent or child?
- Does it 'feel' wrong?

If the answer to any of these questions is "Yes", please stop and consult your reporting manager, the Ethics Counsellor, the Human Resource department, the Legal department or any member of the senior management team, to assist you in making the decision.

When faced with a dilemma: Stop, Think, Act Responsibly

NOTE

The Code does not provide a comprehensive and complete explanation of all expectations from a company standpoint or obligations from a stakeholder standpoint.

Our employees have a continuing obligation to familiarise themselves with all applicable law, group-level advisories and policies, company-level policies, procedures and work rules as relevant. For any guidance on interpretation of the Code, we may seek support from our company's Ethics Counsellor or from the group's Chief Ethics Officer, as appropriate.

All joint ventures are encouraged to adopt the Tata Code of Conduct (TCOC) or a code of conduct that incorporates all elements of the TCOC.

This version of the Tata Code of Conduct supersedes all earlier versions and associated documents and stands effective from 29th July, 2015.

For any query or clarification on the Code, please contact the office of the group's Chief Ethics Officer via email at: ethicsoffice@tata.com.



TATA CODE OF CONDUCT – 2015

I acknowledge that I have received the Tata Code of Conduct.

I have read the Tata Code of Conduct and I acknowledge that as a Tata employee, I am required to comply with the guidelines described therein and failure to do so may subject me to action as per my employment terms and relevant company policies.

If I have a concern about a violation, or a potential violation of the Tata Code of Conduct, I understand that there are channels available to me in my company to report such concerns. By making use of these channels when necessary, I will play my part in maintaining the high ethical standards to which we hold ourselves.

Signature: _____

Date: _____

Name: _____

Department: _____

Address: _____

(Please submit this declaration to your Ethics Counsellor or the Human Resource department of your company.)



For further information on the Code please contact:
 The Ethics Office,
 Tata Sons Ltd.,
 Bombay House,
 24, Homi Mody Street,
 Mumbai – 400001, India.
 Email: ethicsoffice@tata.com

HEALTH AND SAFETY POLICY

We, at Tata Power, reaffirm our belief that the health and safety of our stakeholders is of the utmost importance and takes precedence in all our business decisions. In pursuit of this belief and commitment, we strive to:

- Maintain and proactively improve our management systems to minimize health and safety hazards to our stakeholders and all others influenced by our activities.
- Comply and endeavour to exceed all applicable occupational health & safety legal and other requirements by setting the highest standards.
- Integrate health & safety procedures and best practices into every operational activity with assigned line-functional responsibilities at all levels, for improving and sustaining health & safety performance.
- Involve our employees in maintaining a safe and healthy work environment through risk assessments, periodic reviews of operational procedures, safe work methods and adoption of new technology.
- Develop a culture of safety through active leadership and provide appropriate training at all levels to enable employees developing their skills to work safely.
- Incorporate appropriate health & safety criteria into business decisions for selection of plant and technology, performance appraisal of individuals and appointments in key positions.
- Ensure availability at all times of appropriate resources to fully implement the health & safety policy of the company.
- Promptly report incidents, investigate for root causes and ensure lessons learnt shared and deployed across the company.
- Ensure service providers and their workmen align with company's safety codes and practices for the health and safety of personnel working with us.
- Set safety & health metrics as indicators of excellence, monitor progress and continually improve performance.

We shall actively communicate this policy to all stakeholders by suitable means and periodically review its relevance in continuously changing business environment.



(Praveer Sinha)
CEO & Managing Director

Date: 15th June, 2018

TATA POWER

Lighting up Lives!

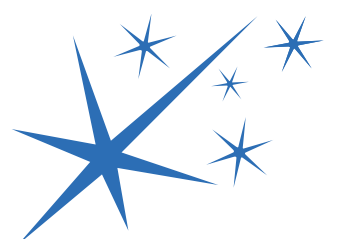

CORPORATE ENVIRONMENT POLICY

Tata Power is committed to a clean, safe and healthy environment, and we shall operate our facilities in an environmentally sensitive and responsible manner. Our commitment to environmental protection and stewardship will be achieved by:

- Complying with the requirements and spirit of applicable environmental laws and striving to exceed required levels of compliance wherever feasible
- Ensuring that our employees are trained to acquire the necessary skills to meet environmental standards
- Conserving natural resources by improving efficiency and reducing wastage
- Making business decisions that aim towards sustainable development
- Engaging with stakeholders to create awareness on sustainability



(Praveer Sinha)
CEO & Managing Director

Date: 15th June, 2018

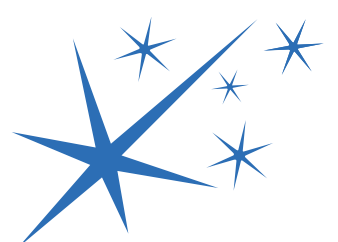

FORMAT OF EMD – Bid Guarantee BG

FORMAT OF EMD – Bid Guarantee BG

Note: a) Format shall be followed in toto

b) Claim period of six months must be kept. In case of Bank is not ready to give BG for six months and claim period of six months EMD BG valid of one year to be given

c) The guarantee to be accompanied by the covering letter from the bank confirming the signatories to the guarantee on the Bank's letter head.

The Tata Power Co Ltd
34, Sant Tukaram Road
Carnac Bunder,
Mumbai 400 009

Whereas (Name of the Contractor), a Company incorporated under the Indian Companies Act 1956, having its Registered office at _____, (hereinafter called the "BIDDER") has in response to your Invitation to Bid against Enquiry No. _____ dated _____, for (name of work), offered to supply and/or execute the works as contained in Employers letter dated _____.

AND WHEREAS BIDDER is required to furnish to you a Bank Guarantee for the sum of Rs. _____/(Rupees ____ only) as Earnest Money against Bidder's offer as aforesaid.

AND WHEREAS we, (name of the bank) having our Registered Office at _____ and Branch office at _____, have at the request of Bidder, agreed to give you this Guarantee as hereinafter contained.

NOW THEREFORE, in lieu of earnest money deposit, we, the undersigned, hereby covenant that the aforesaid Bid of the BIDDER shall remain open for acceptance by you during the period of validity as mentioned in the Bid Document or any extension thereof as requested by you and if Bidder shall for any reason back out, whether expressly or impliedly, from this said Bid during the period of its validity or any extension thereof as aforesaid, we hereby guarantee to you the payment of the sum of Rs. _____/(Rupees ____ only) on demand and without demur and notwithstanding the existence of any dispute between you and the BIDDER in this regard and we hereby further agree as follows:

- (a) You shall have the right to file/make a claim on us under the Guarantee for a further period of six months from the said date of expiry.
- (b) That this guarantee shall not be revoked during its currency without your written express consent.
- (c) That you may without affecting this guarantee grant time or other indulgence to or negotiate further with BIDDER in regard to the conditions contained in the said Bid document and thereby modify these conditions or add thereto any further conditions as may be mutually agreed upon between you and BIDDER.
- (d) That the guarantee hereinbefore contained shall not be affected by any change in the constitution of our Bank or in the constitution of BIDDER.

- (e) That any account settled between you and BIDDER shall be conclusive evidence against us of the amount due hereunder and shall not be questioned by us.
- (f) That this guarantee commences from the date hereof and shall remain in force till BIDDER, if his Bid is accepted by you, furnishes the Contract Performance Guarantee as required under the said specifications and executes formal Contract Agreement as therein provided or till ____Days (__ days) from the date of submission of the Bid by the BIDDER i.e. (expiry date), whichever is earlier.
- (g) That the expression, BIDDER and Bank, and OWNER herein used shall, unless such an interpretation is repugnant to the subject or context, include their respective successors and assignees.
- (h) Notwithstanding anything herein contained, our liability under this guarantee is limited to Rs._____/-(Rupees _____ only) and the Guarantee will remain in force upto and including and shall be extended from time to time for such period or periods as may be desired by you. Unless a demand or claim under this Guarantee is received by us in writing within six months from (expiry date), i.e. on or before (claim period date), we shall be discharged from all liabilities under this guarantee thereafter.
- (i) Any claim/extension under the guarantee can be lodgeable at issuing outstation bank or at Mumbai branch and claim will also be payable at Mumbai Branch. **(To be confirmed by Mumbai Branch by a letter to that effect)**

Notwithstanding anything contained hereinabove :

- a) Our liability under this Bank Guarantee shall not exceed Rs._____/-(Rupees _____ only).
- b) This Bank Guarantee shall be valid upto ----- 200.
- c) Our Liability to make payment shall arise and we are liable to pay the guaranteed amount or any part there of under this Bank Guarantee only and only if you serve upon us a written claim or demand on or before ----- 200.